

# SICO INSERTABLE LEG STAGE & RISER SYSTEM

SICO's insertable leg technology is a very affordable solution to staging and riser needs. Decks lock onto legs securely with flexible pin connectors. Quick, easy, sturdy, dependable and quiet!

**FREE Custom Design Service!** If you can't find the configuration that works for you, send us a drawing of your room (including measurements), list your desired capacity, shape and type of SICO stage and accessories. SICO will design a custom drawing just for you.



## 3 Tier 3' Deep Modules

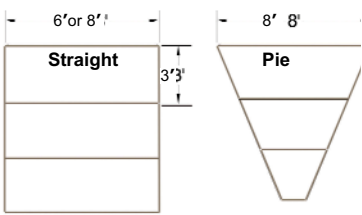

Module I

Module J

## 4 Tier 3' Deep Modules

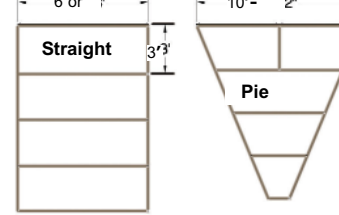

Module K

Module L

## 3 Tier 4' Deep Modules

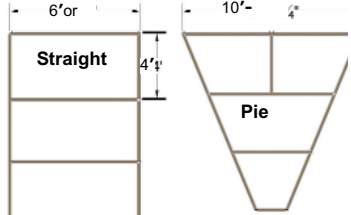

Module M

Module N

PLAN 21

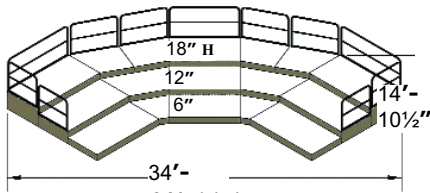

3 Module I  
2 Module J

3' deep sections, 72 seated capacity including

PLAN 24

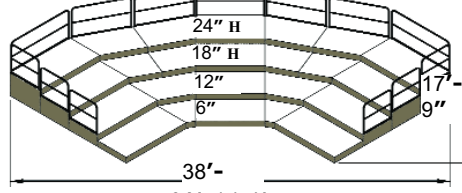

3 Module K  
2 Module L

3' deep sections, 96 seated capacity including

PLAN 27

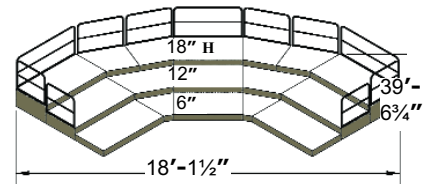

3 Module M  
2 Module N

4' deep sections, 59 seated capacity including

PLAN 22

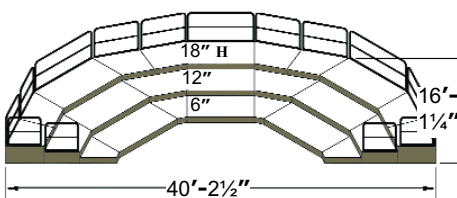

3 Module I  
4 Module J

3' deep sections, 92 seated capacity including

PLAN 25

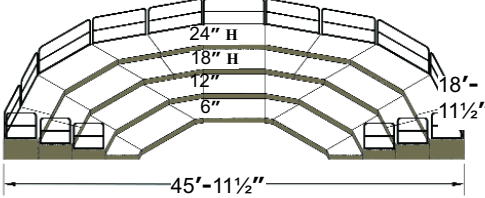

3 Module K  
4 Module L

3' deep sections, 128 seated capacity including

PLAN 28

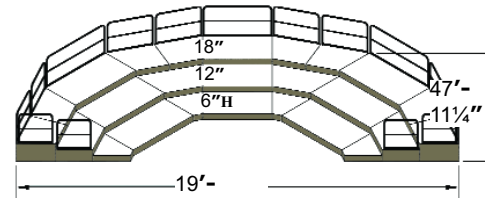

3 Module M  
4 Module N

4' deep sections, 80 seated capacity including

PLAN 23

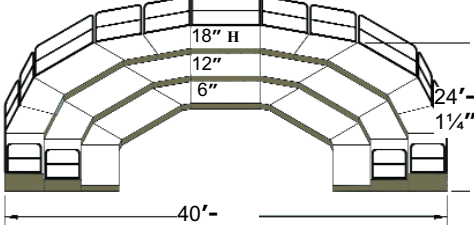

5 Module I  
4 Module J

3' deep sections, 131 seated capacity including

PLAN 26

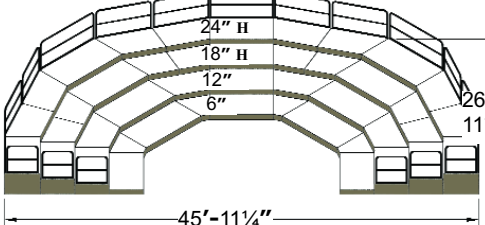

5 Module K  
4 Module L

3' deep sections, 177 seated capacity including

PLAN 29

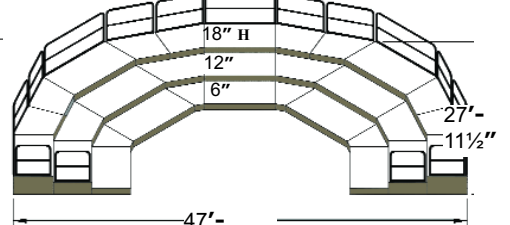

5 Module M  
4 Module N

4' deep sections, 108 seated capacity including

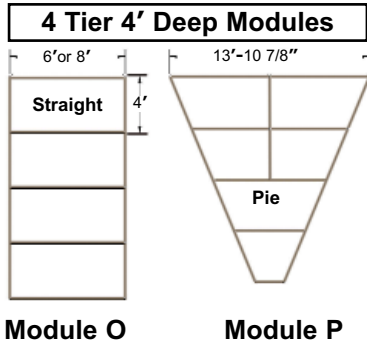
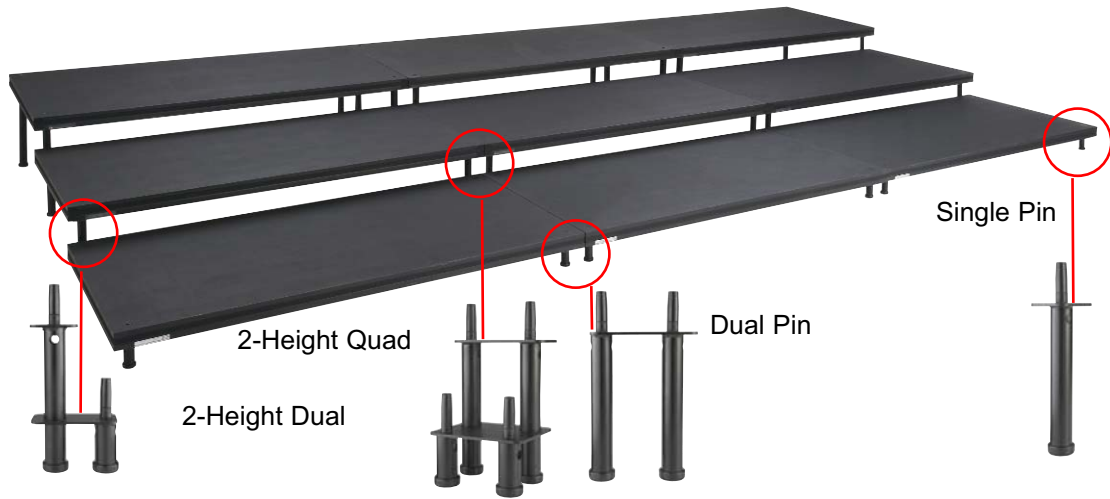

SICO's Insertable Leg stages allow easy-to-use rectangular configurations. Insertable legs also allow more height choices to allow for greater number of occupants or changes in location.  
**Leg height choices available in 6" or 8" increments.**

**PLAN 30**

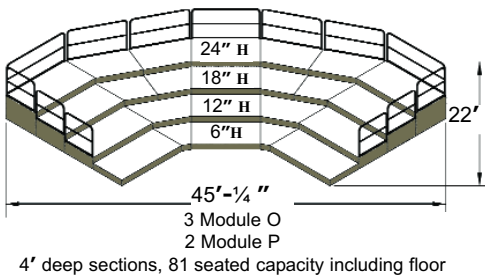

**PLAN 33**

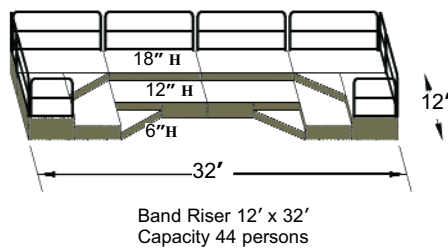

**PLAN 36**

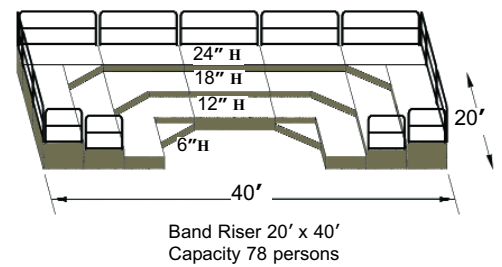

**PLAN 31**

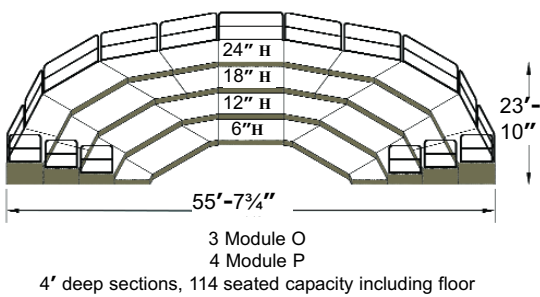

**PLAN 34**

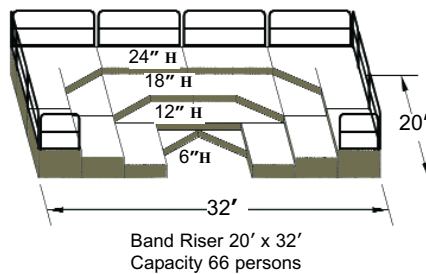

**PLAN 37**

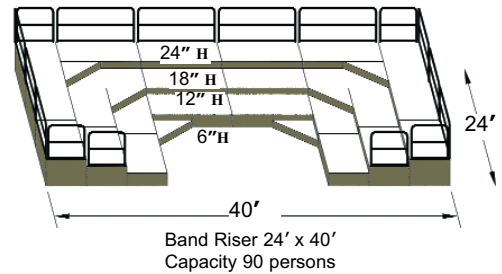

**PLAN 32**

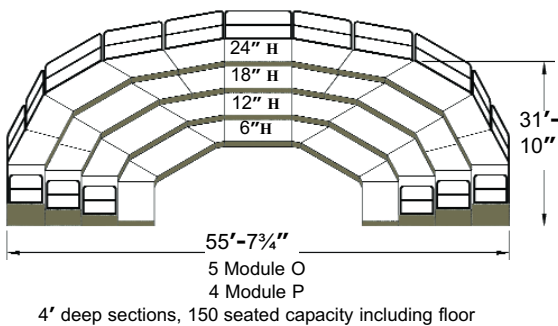

**PLAN 35**

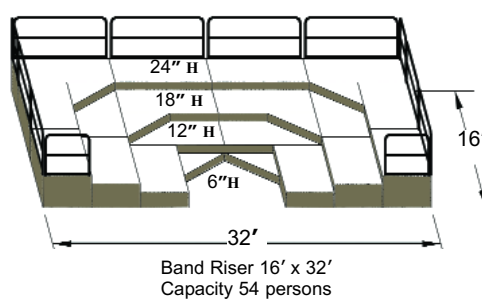

**PLAN 38**

