

SICO® 2800 ConverTable

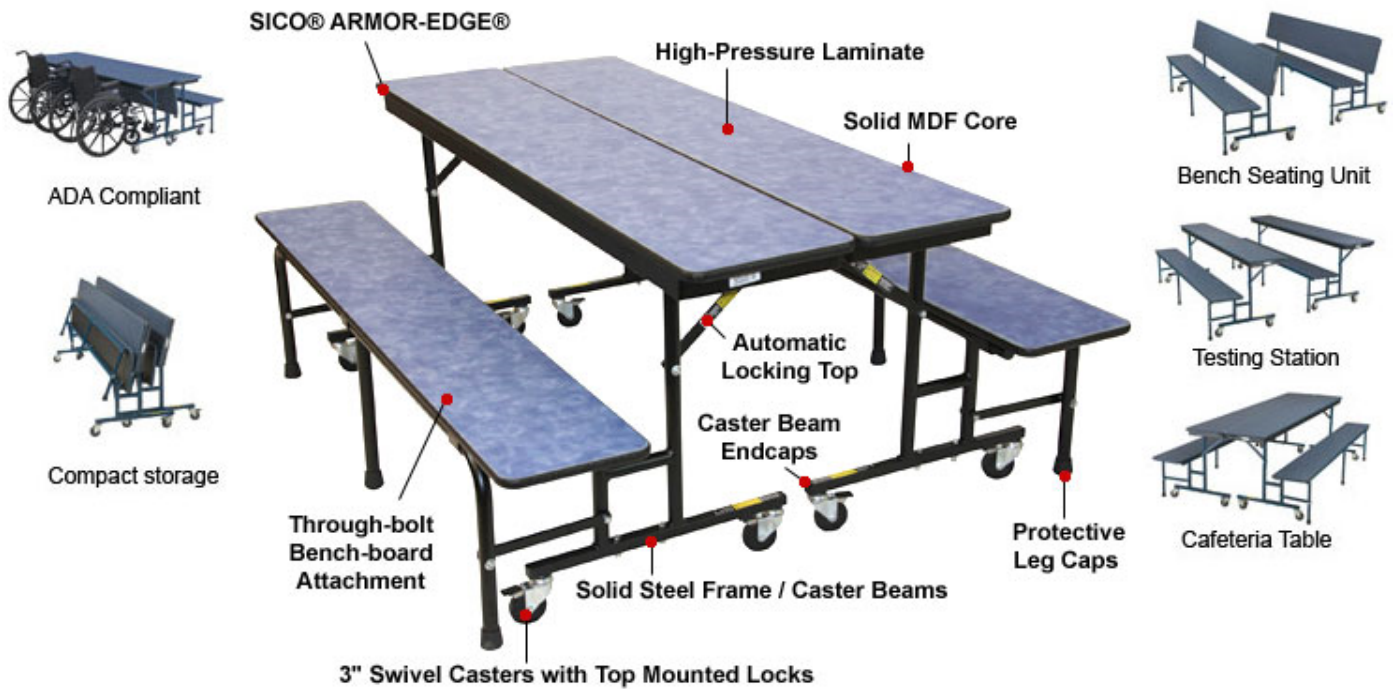

Three Tables for the Price of One!

- 1) Use as a single unit (bench and tabletop) for testing and seminar applications.
- 2) Transform unit into bench seating mode, perfect for auditorium use.
- 3) Link units together for use as a cafeteria/social-seating table.

Features, Advantages & Benefits

SICO® ARMOR-EDGE®

- The most durable edge available.
- Provides an incredibly tough edge to take hard everyday abuse without damage.
- Hermetically seals the tabletop for sanitary purposes and prevents moisture from entering table top core.
- Proven track record for long-term durability.

High-pressure Laminate

- Tough .04" (.10cm) thickness high-pressure laminate for added durability and long-term wear.
- A large variety of striking colors and patterns are available to fit any cafeteria decor.

Table Top Solid MDF Core

- Laminate tops are made with extremely durable ¾" MDF core material that is stronger than plywood or particleboard, is light-weight, and resists warping.

Rigid Vinyl Backer Sheet

- Applied to the underside of the tabletops for moisture control and easy cleanup (including gum removal), stain resistance and fantastic appearance.
- Far superior to all types of paper backers.

Multiple Use Configurations

- Quickly and easily converts from table to bench with back rest.
- Use as a cafeteria table to increase capacity over table and chairs.
- Ideal for group testing, offering ample work space.

Tamper Proof Expansion Rivets – Fastens tabletop firmly to the frame and will not work loose like ordinary screws.

Aircraft Lock-nuts – Tamper-resistant lock-nuts are used at all pivot points and won't loosen over time.

Automatic Locking Top - Top stays locked when folded out for use.

Simple Operation - Faster and quieter set-up than chairs.

Solid Steel Frame / Caster Beams - 14 gauge, square tubular steel adds superior strength and durability.

3" Swivel Casters with Top Mounted Locks – Multi-directional casters for ease of mobility. Top mounted locks secure units into place. Non-marring soft, black rubber wheels won't damage floors or carpet.

Protective Neoprene Glides - Non-marring contact with floor keeps table in place and prevents floor damage. Reinforced glides contain metal washers to prevent leg tubes from breaking through bottom.

Unit-to-unit connectors - Connects multiple tables together. Latches easily and keeps tables in place.

Compact Storage - Tables fold & nest for compact storage. Each additional unit takes only 8" (20cm) of storage space.

Serial Number - Permanently marked for easy identification.

Warranty – Protected by a **15-Year Warranty** against manufacturer's defects. **Lifetime Warranty** on welds.

Specifications

Model No.	Top Dimensions & Seating Capacity:	Top Heights	Storage Dimensions	Weight
TEA42D??02??02B	6'L x 14"W (183cm x 36cm) Seats 8 children or 6 adults (w/2 tables joined)	27" (69cm)	72"L x 22-1/2"W (183cm x 57cm)	125 lbs / 57kg
TEA42F??02??02B	6'L x 14"W (183cm x 36cm) Seats 8 children or 6 adults (w/2 tables joined)	29" (74cm)	72"L x 22-1/2"W (183cm x 57cm)	125 lbs / 57kg
TEC42D??02??02B	8'L x 14"W, (244cm x 36cm) Seats 12 children or 8-10 adults (w/2 tables joined)	27" (69cm)	96"L x 22-1/2" W (244cm x 57cm)	130 lbs / 59 kg
TEC42F??02??02B	8'L x 14"W, (244cm x 36cm) Seats 12 children or 8-10 adults (w/2 tables joined)	29" (74cm)	96"L x 22-1/2" W (244cm x 57cm)	130 lbs / 59 kg



For More Information Visit: <http://www.sicoinc.com/convertable.php>

7525 Cahill Road, Minneapolis MN 55439

1.800.533.7426

Laminate Options



Wild Cherry
(49)



Bannister Oak
(10)



Nepal Teak
(74)



Kensington
Maple (77)



Gray Nebula
(38)



Graphite
Nebula (50)



Windswept (51)



Saffron Tigris
(54)



Navy Legacy
(53)



Green Tigris
(76)



Karratha Brush
(70)



Maroochy
Brush (71)



Woolamai
Brush (72)

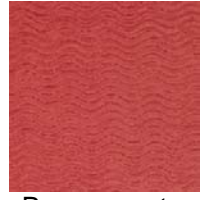

Pomegranate
(78)

* Check with a SICO Representative for additional laminate choices available.

Table Top Armor-Edge Options



Black (02)

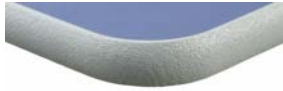

Gray (03)



Burgundy (04)



Blue (05)



Brown (06)

Powder-coat Frame Options



Black (B)

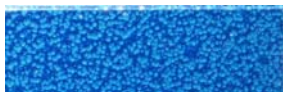

Blue Hammered (H)



Copper Vein (R)



Silver (L)

SICO® 2800 ConverTable Table Dimensions

6' Dimensions

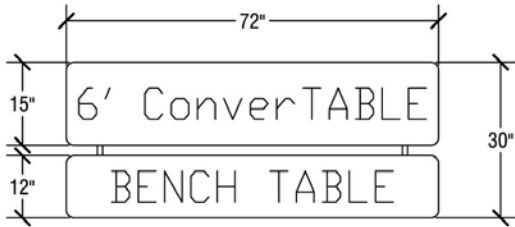

Testing Configuration



Auditorium Configuration

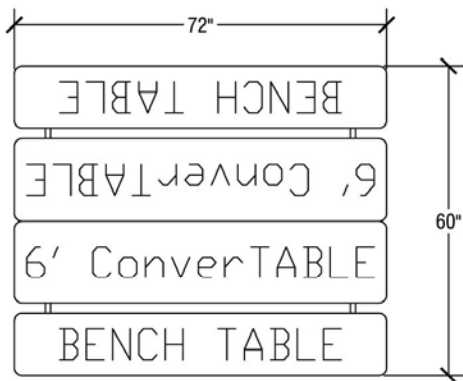

Cafeteria Configuration

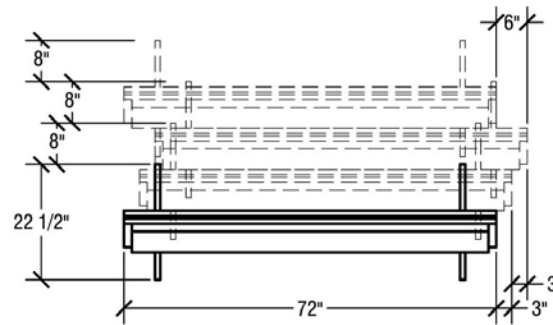

Storage Configuration

SICO 6' ConverTABLE Table

Top Height: 29" or 27"

Folded Height: 33 1/2" h or 31 1/2"

Table Top Size: 15" x 72"

8' Dimensions

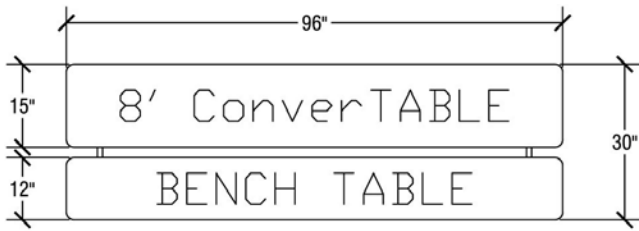

Testing Configuration

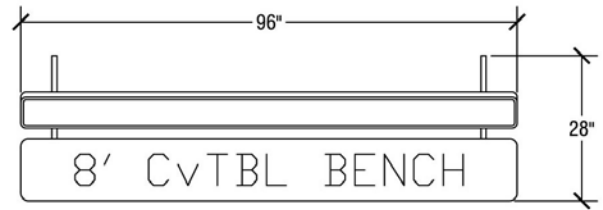

Auditorium Configuration

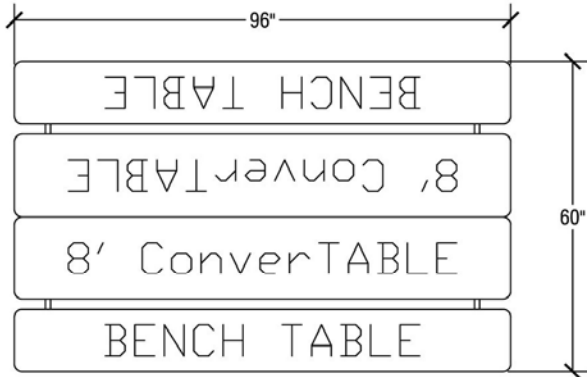

Cafeteria Configuration

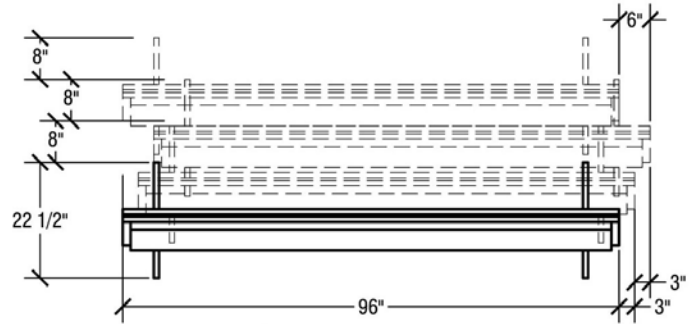

Storage Configuration

SICO 8' ConverTABLE Table

Top Height: 29" or 27"

Folded Height: 33 1/2" h or 31 1/2"

Table Top Size: 15" x 96"



For More Information Visit: <http://www.sicoinc.com/convertable.php>

7525 Cahill Road, Minneapolis MN 55439

1.800.533.7426