

SICO INSERTABLE LEG STAGE & RISER SYSTEM

SICO's insertable leg technology is a very affordable solution to staging and riser needs. Decks lock onto legs securely with flexible pin connectors. Quick, easy, sturdy, dependable and quiet!

FREE Custom Design Service! If you can't find the configuration that works for you, send us a drawing of your room (including measurements), list your desired capacity, shape and type of SICO stage and accessories. SICO will design a custom drawing just for you.



3 Tier 3' Deep Modules

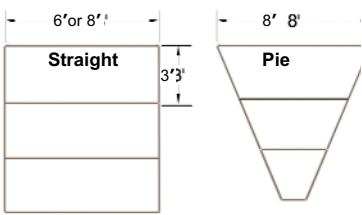

Module I

Module J

4 Tier 3' Deep Modules

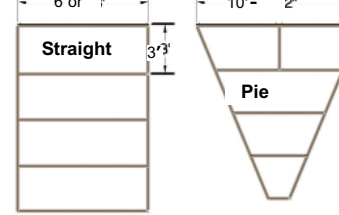

Module K

Module L

3 Tier 4' Deep Modules

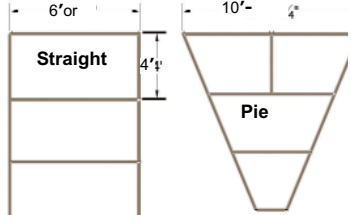

Module M

Module N

PLAN 21

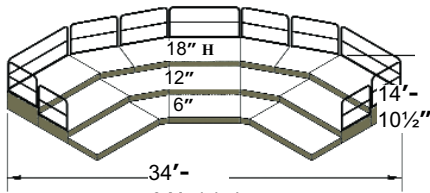

3 Module I
2 Module J
3' deep sections, 72 seated capacity including

PLAN 24

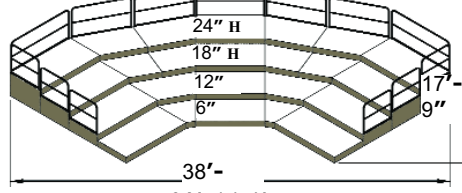

3 Module K
2 Module L
3' deep sections, 96 seated capacity including

PLAN 27

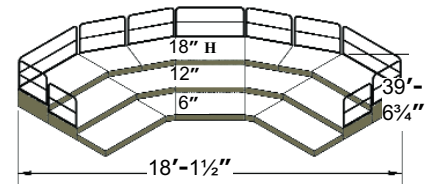

3 Module M
2 Module N
4' deep sections, 59 seated capacity including

PLAN 22

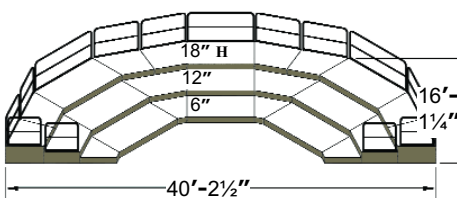

3 Module I
4 Module J
3' deep sections, 92 seated capacity including

PLAN 25

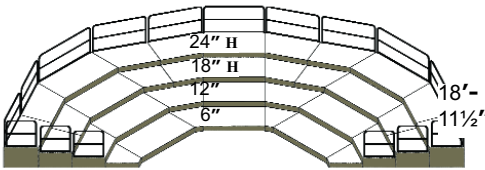

3 Module K
4 Module L
3' deep sections, 128 seated capacity including

PLAN 28

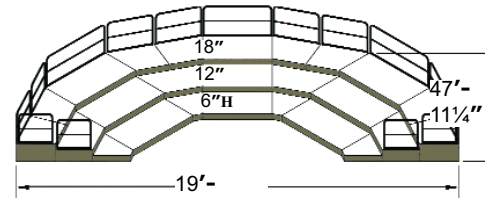

3 Module M
4 Module N
4' deep sections, 80 seated capacity including

PLAN 23

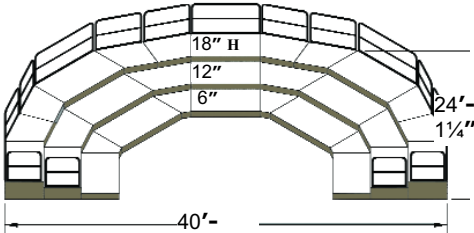

5 Module I
4 Module J
3' deep sections, 131 seated capacity including

PLAN 26

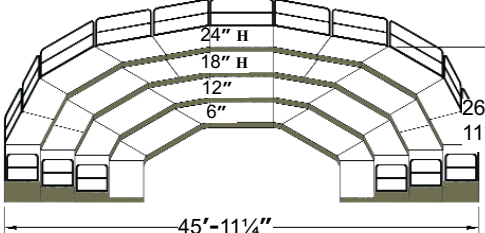

5 Module K
4 Module L
3' deep sections, 177 seated capacity including

PLAN 29

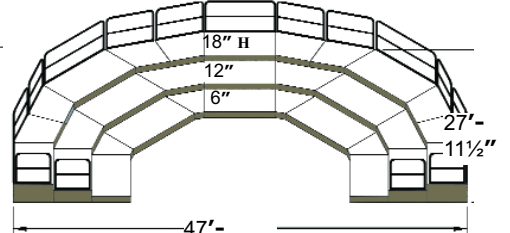

5 Module M
4 Module N
4' deep sections, 108 seated capacity including

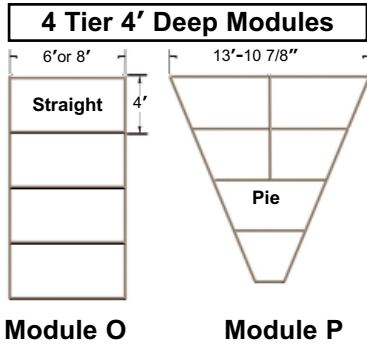
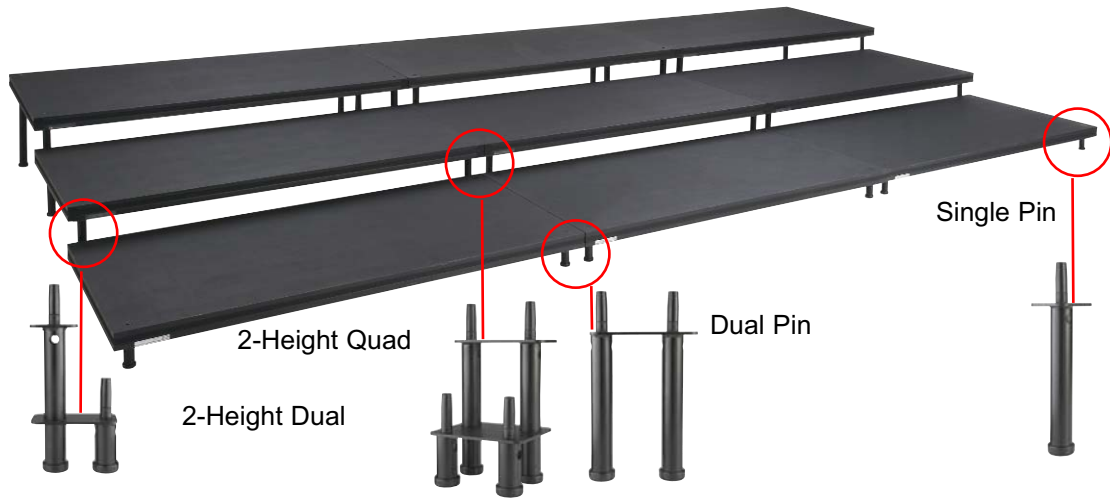

SICO's Insertable Leg stages allow easy-to-use rectangular configurations. Insertable legs also allow more height choices to allow for greater number of occupants or changes in location.
Leg height choices available in 6" or 8" increments.

PLAN 30

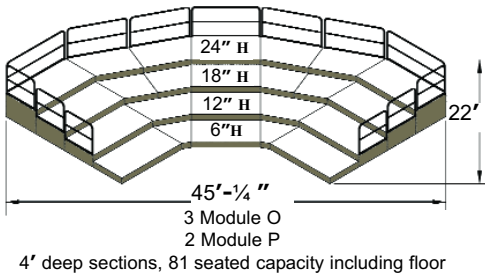

PLAN 33

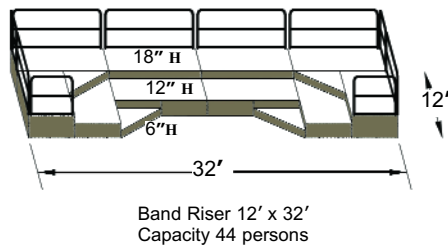

PLAN 36

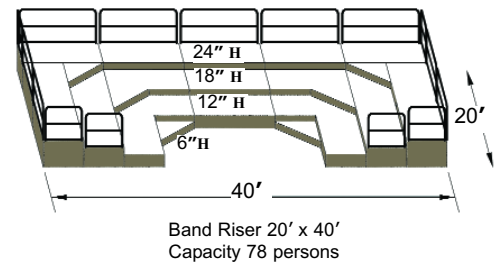

PLAN 31

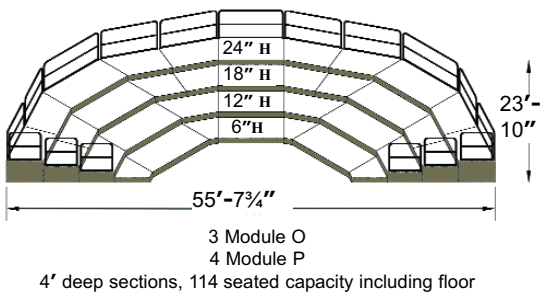

PLAN 34

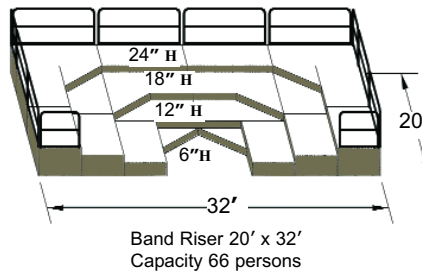

PLAN 37

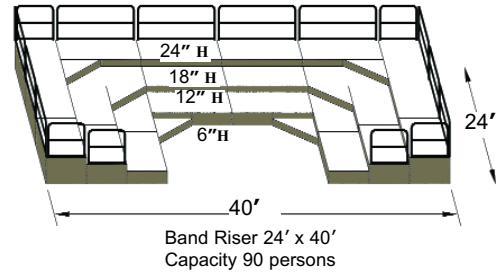

PLAN 32

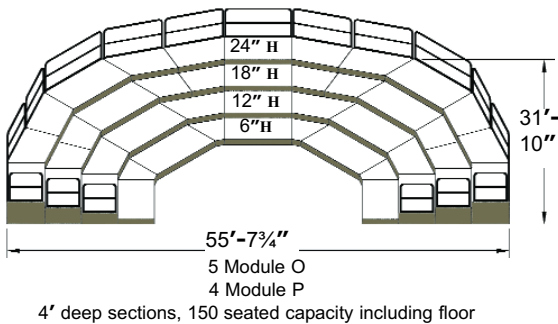

PLAN 35

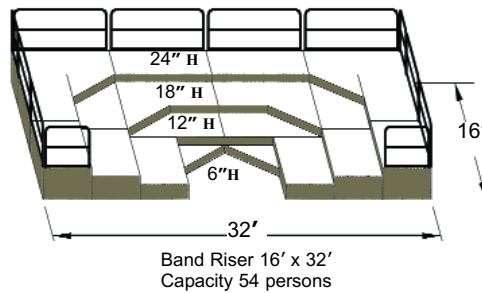

PLAN 38

