

Communicator Table



Easy Lifting Tables.
Forever.
Guaranteed.



*Desert Zephyr (4841) Laminate
Black Armor-Edge
Chrome Frame
Black Round Stools
Shadow Gray Caster Thread Guards*

SICO® QUALITY

Now with an UltraLight MDF table top core, HSLA legs, new stool shapes, new colors and the EXCLUSIVE SICO® Strut™ lift assist, each element of the Communicator table works in harmony to create the best table on the market. The aptly named Communicator table allows for easy eye contact, promoting conversation and creativity. Never worry about lifting a heavy table again. Ever. Guaranteed. It's time to re-imagine the possibilities of your space.



Comfort Stools
(With Optional Accent Guard)
Designed for comfort, style and easy maintenance.



HSLA Steel Legs
High Strength Low Alloy steel.
Lighter and stronger.
Double the yield strength of competitive tables.



SICO® Strut™
Lift assist. No loss of power. No maintenance. No more heavy tables over time.

Communicator Features

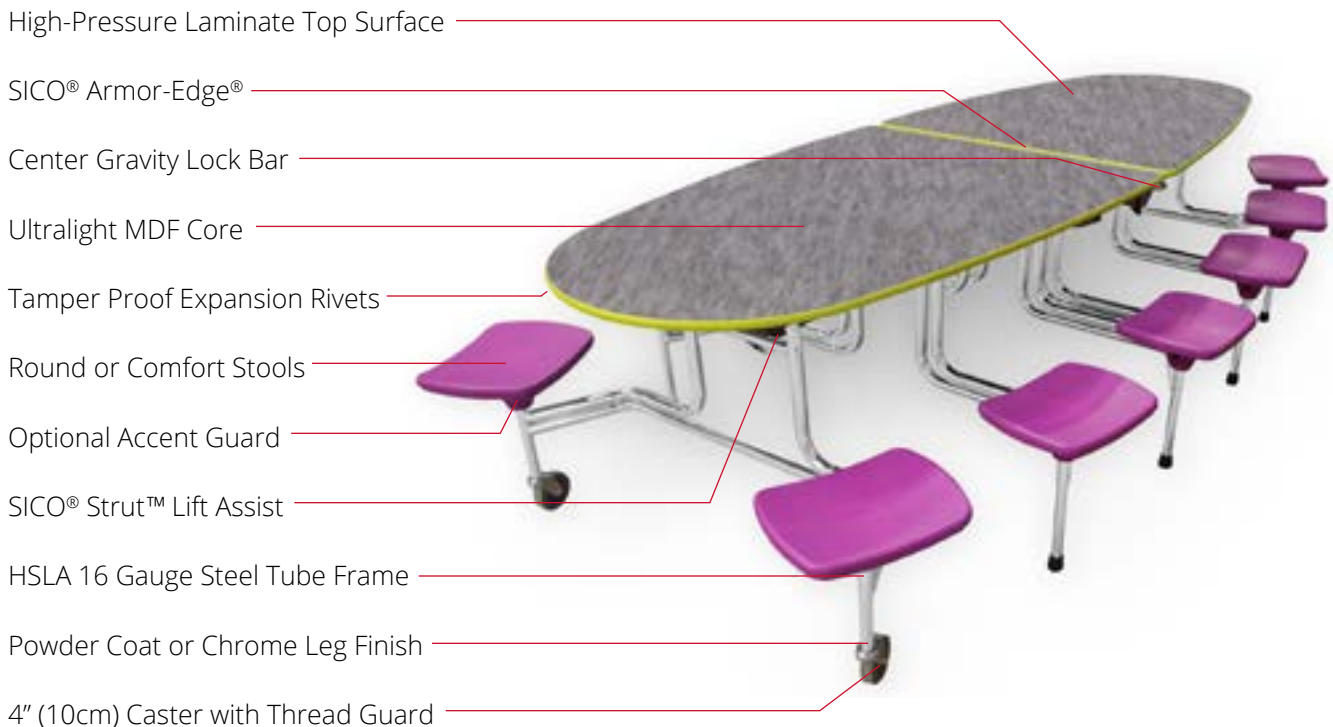

Table Top

Spacious Elliptical Shape Table

Top: Unique elliptical shape allows eye contact, promoting quieter interaction. Top easily fits 12 standard size lunch trays.

UltraLight MDF Core Table Top:

Made with extremely durable 18mm MDF manufactured using 100% fresh pine fiber. Stronger than plywood or particleboard, light-weight, and resists warping.

High-Pressure Laminate:

Tough .040" (.10cm) thickness high-pressure laminate for added durability and long-term wear. Nearly 200 standard colors and patterns are available to fit any cafeteria decor.

Rigid Backer Sheet: Applied to the underside of the tabletops for moisture control and easy cleanup (including gum removal), stain resistance, fantastic appearance and balanced top construction.

SICO® Armor-Edge®: The most durable edge available. Provides an incredibly tough edge to take hard everyday use without damage. Hermetically seals the tabletop for sanitary purposes and prevents moisture from entering table top core. Now available in 12 standard colors.

Tamper Proof Expansion Rivets:

Fastens tabletop firmly to the frame.

Center Gravity Lock Bar:

½" (1.3cm) center gravity lock bar prevents anyone from raising center of table by sitting on the table end. Easily released from either side.

Vertical Hinges with Low

Friction Bushings: Two 7 gauge self cleaning hinges won't trap food while providing additional strength, security and durability.

Table Legs

HSLA 16 Gauge Tube: High strength low alloy steel tube delivers a yield strength of 70,000 psi, double the yield strength of competitors tables while being lighter in weight. Flexibility is designed into the legs to allow for contained motion and the way students use the tables today.

Patented Square Shape Stool

Support Post: Prevents any rotational movement of the stool seat. Lower portion of support post retains round shape, preserving the elegant look of the table.

Leg Retainer: Heavy duty, low-friction polymer leg retainer holds legs securely into the frame. Eliminates any metal-on-metal wear and no need for maintenance at this pivot point.

Protective Neoprene Glides:

Non-marring contact with floor keeps table in place and prevents floor damage. Reinforced glides contain metal washers to prevent leg tubes from breaking through bottom.

Aircraft Lock-Nuts: Tamper-resistant lock-nuts are used at all mounting points and won't loosen over time.

Exclusive SICO® Strut™ Lift Assist

No Loss of Power: Never lose lifting power for the lifetime of the product. Guaranteed.

No Maintenance: No exposed operating components. No parts to replace. Constructed using a patented design.

FEATURES & BENEFITS

Transport & Storage

Caster: Each TC-65 has four 4" (10cm) non-marking casters with a wide surface area for smoother rolling. Stems on each caster are solid steel. Plastic thread guards prevent the accumulation of debris keeping wheel rotating freely. The thread guard is available in a variety of colors.

Transport Lock: The handle unlocks the latch from either side of the table, allowing the SICO® Strut™ to assist in lowering the table slowly into the use position.

Mobility and Storage: The robust caster and SICO® Strut™ make table lifting easy. Simply lift in the center and roll into use or storage. No caddies needed.

Limited Lifetime Warranty

Protected by a Lifetime Warranty on welds and SICO® Strut™. Limited Lifetime Warranty on table system. Visit www.sicoinc.com for all warranty details.

Serial Number: Tables are permanently marked for easy identification.

Space Design

Take advantage of our FREE space design service to determine the optimal layout and number of products for your space.

OPTIONS

Choose Height & ADA Options

Choose from 27" (69cm) or 30" (76cm) table heights to accommodate your students. Also choose the ADA option which has a 30" (76cm) top height with eight stools and four wheelchair spaces.

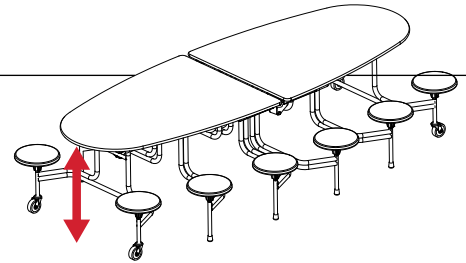

Choose Top Laminate

Choose from nearly 200 standard high pressure laminates for a custom look. Visit www.sicoinc.com for a complete list of standard options that are sure to complement your space.

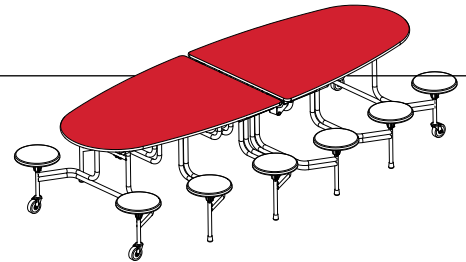

Choose Armor-Edge® Color

The most durable edge available now comes in a wide variety of colors. Customize the look of your space and choose colors to match or accent table top laminate.

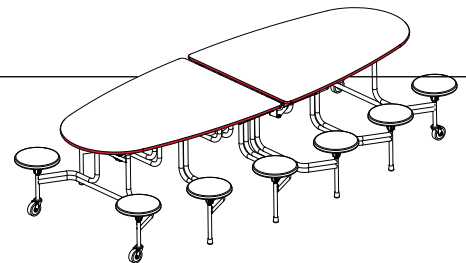

Choose Stool Type & Color

Choose from the original round ABS Plastic stool or our modern Comfort Stool (shown with optional accent guard) with its exclusive curvature shape providing 20% more surface area, it's simply more comfortable for longer.



Choose Leg Color

Choose from four standard leg finishes. Choose either the high finish and classic look of polished chrome or the durable beauty and neutral colors of a slightly textured powder coat.

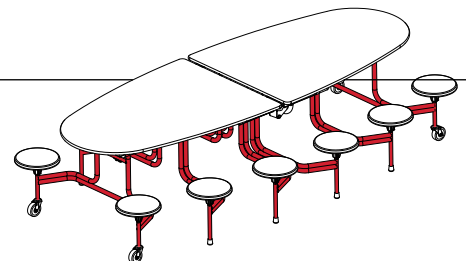

Choose Caster Thread Guard Color

The robust caster design features a plastic thread guard that does not move when the wheel spins preventing accumulation of debris in the bearing. The thread guard is available in color options to match or accent Armor-Edge® colors.

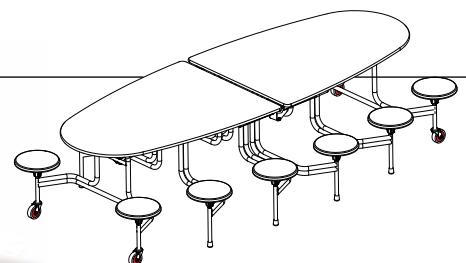

THINK BIG!

27" (69cm)

30" (76cm)

30" (76cm) ADA

Height & ADA

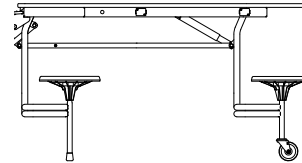
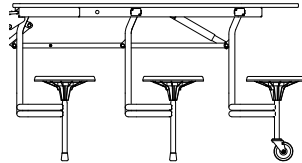
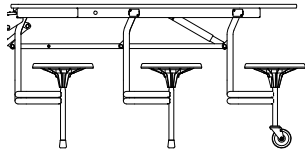

Top Laminate



Armor-Edge® Color

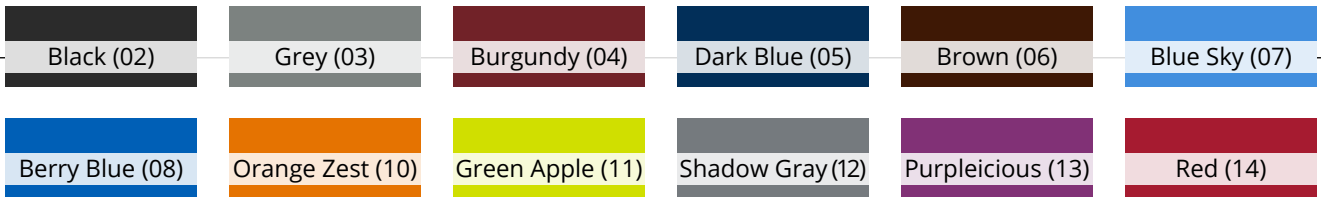

Stool Type & Color

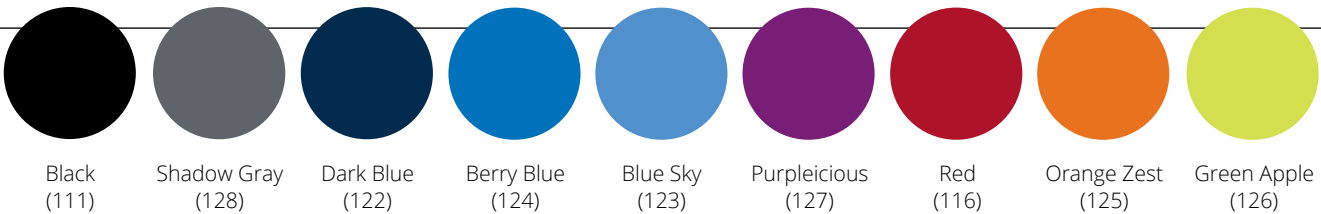

Leg Color

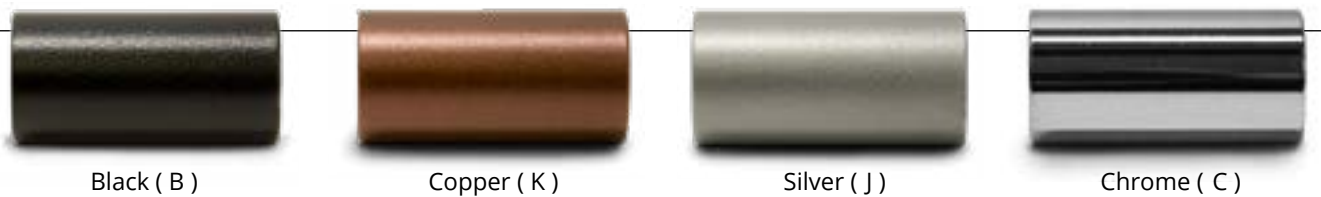

Caster Thread Guard Color

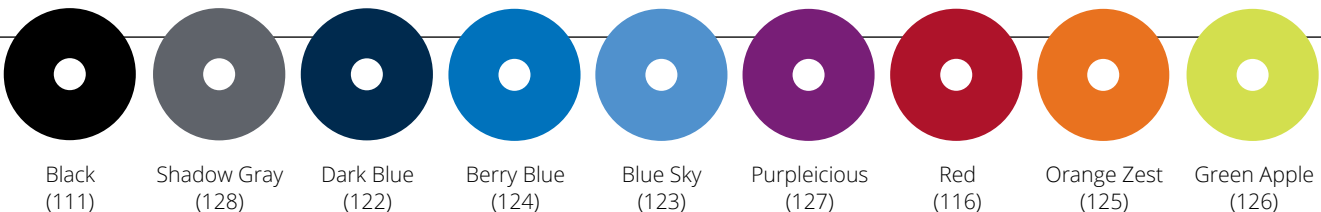

*All colors are representative only

SPECIFICATIONS

Ordering Information

Description	Seating Capacity	Weight
Communicator	12	249 lbs. (113kg)
Communicator - ADA	12 (8 Stools/4 Wheelchairs)	235 lbs. (107kg)

In-Use Dimensions

Description	A Table Top Length	B Table Top Width	C Table Top Height
Communicator	10' (305cm)	42" (76cm)	27" (69cm) or 30" (76cm)
Communicator - ADA	10' (305cm)	42" (76cm)	30" (76cm)

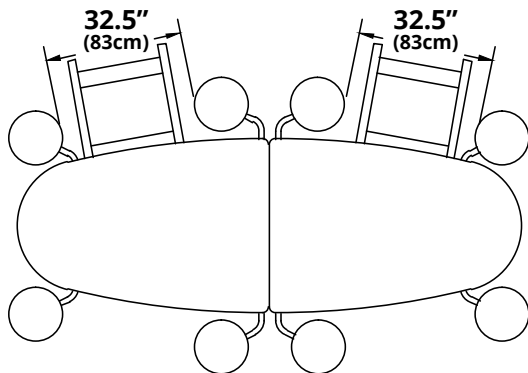
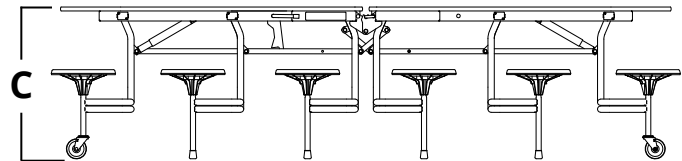
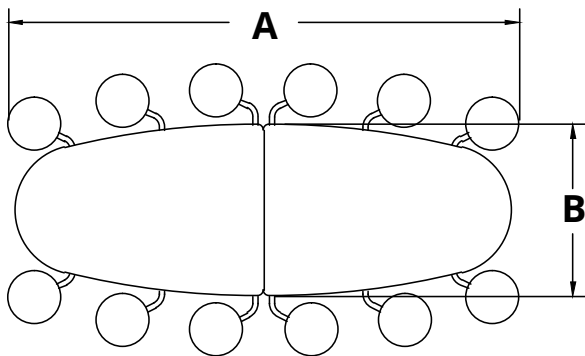

Storage Dimensions

Description	A Footprint Length (Single Unit)	B Footprint Width (Single Unit)	C Add'l Footprint Length (Each Add'l)	D Height* (Folded)
Communicator	45" (114cm)	71" (181cm)	34" (87cm)	74" (188cm) or 77" (196cm)
Communicator-ADA	45" (114cm)	71" (181cm)	34" (87cm)	77" (196cm)

*Folded Height is Dependent on Top Height

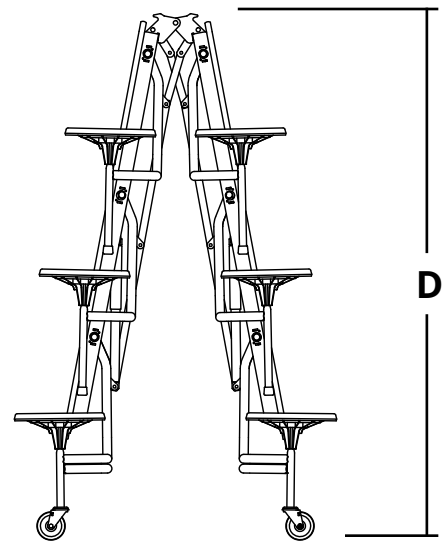
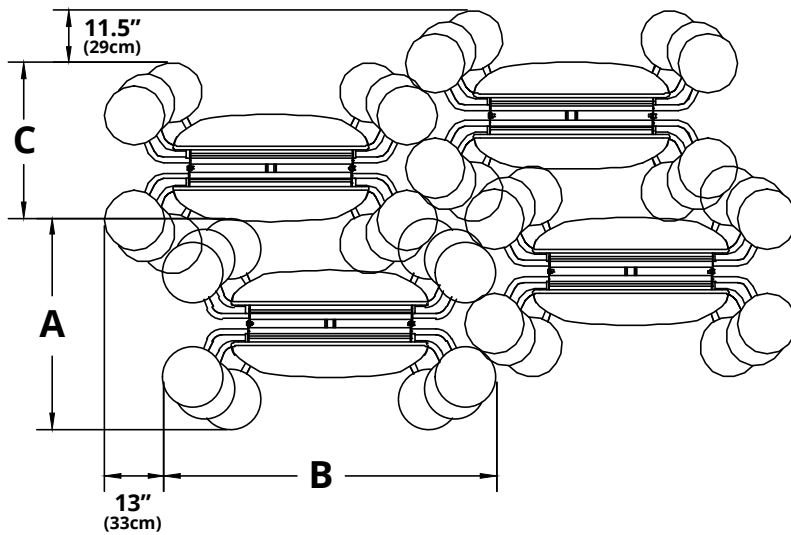

ADA Compliant

Select the ADA option to add wheelchair spaces along side of the attached stools. Easily roll in and out of the ADA space and still communicate easily with others on the standard stools.



WANT TO FIND OUT MORE?

Visit www.sicoinc.com to see more of our wide variety of innovative products.



SICO Incorporated -
Global Headquarters
SICO America Inc.
Tel: 1 800 328 6138
Email: sales@sicoinc.com

SICO Japan Inc.
Tel: +81(3) 3288 0145
Email: info@sico-japan.com

SICO Asia PTE LTD
Tel: (65) 6500 0800
Email: sales@sicoasia.com

SICO Middle East DMCC
Tel: (971) 4 880 9388
Email: sales@sico-me.com

SICO Europe Limited
Tel: +44(0) 1303 234 000
Email: sales@sico-europe.com

SICO South Pacific Limited
Tel: +61(2) 4336 1333
Email: sales@sicosp.com.au