

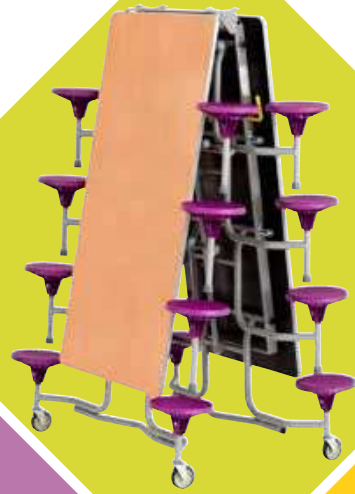

Innovative Mobile Furniture
for the Education Market.



Dining room seating solutions.
Versatile seating systems.
Portable performance stages.
Event and performance staging.

SICO® Europe Limited



VISION:
THE TRUSTED GO-TO COMPANY

MISSION:
To provide value-added innovative solutions enabling our customer to transform and better use their space.

CORE VALUES:



INTEGRITY

The quality of being honest and having strong moral principles.



COMMITMENT TO EXCELLENCE

The passionate belief and intense pride in everything we do.



TEAMWORK

The process of working collaboratively to achieve a common goal.



COMMUNICATION

We are stronger when we listen and smarter when we share.

The SICO® World

For over 60 years, SICO® has been a leading, worldwide manufacturer of mobile folding products to help organisations maximise the efficient use of their space. From our extensive range of mobile folding tables to our portable dance floors and easy to use mobile folding stages, we offer a host of innovative products that offer the same ingenuity and quality that so many of our customers have come to expect from SICO®. With such a diverse family of products, SICO® can fulfil the needs of any facility.

SICO® Europe operates from a modern 40,000 sq ft factory in Kent, UK. The SICO® headquarters is in Minneapolis, Minnesota, USA with other manufacturing plants located in America, Asia and Europe. Our presence in the global education and hospitality market place speaks for itself. SICO® has become a global leader of portable product solutions that optimise the use of space. SICO® prides itself in delivering products that last the test of time while continuing a strong tradition of providing superior customer service.



Contents

SICO® Sales and Support 2
 SICO® UK Sustainability 3
 Optimising your space with innovative mobile education equipment 4
 Early Years Foundation Range 6
 Primary through to Secondary Seating 8
 Let us Plan and Design your space 10
 We optimise your space 11
 Advantages of the SICO® Table Seating Unit 12
 Key benefits of Table Seating Units 13
 What makes a SICO® Table Seating Unit so special 14

Dining Seating Solutions

12 Seat Rectangular Table Seating Unit 16
 8 Seat Rectangular Table Seating Unit 18
 Early Years Range Table Seating Solutions 20
 Mobile Folding Bench Table 22
 8ft BY-65 Mobile Folding Bench Table 24
 10ft BY-65 Mobile Folding Bench Table 26
 12ft BY-65 Mobile Folding Bench Table 27
 Communicator Table Seating Unit 28
 Graduate Table Seating Unit with Benches 30
 Graduate Table Seating Unit with Stools 31

Versatile Seating Systems

2800 Bench - 3 in 1 Unit 32

Tables

Flip-Tech Meeting & Workspace Tables 34
 Socializer Whiteboard Table 36
 Socializer Table 37
 Pacer Mobile Folding Table 38
 LB Mobile Folding Table 38
 MultiAppTable 38
 Mobile Folding Conference/Elip Table 39
 Pacer II Table 39

Portable Performance Stages

Series 2000 Mobile Folding Stage 40
 Stage Accessories 42
 Tri-Height Mobile Folding Stage 44
 Harmony Choral Riser 44
 Insta-Theatre 45
 Table Laminate and Stool Colour Options 46
 SICO® Service and Maintenance 48
 SICO® Table Health Checks 49

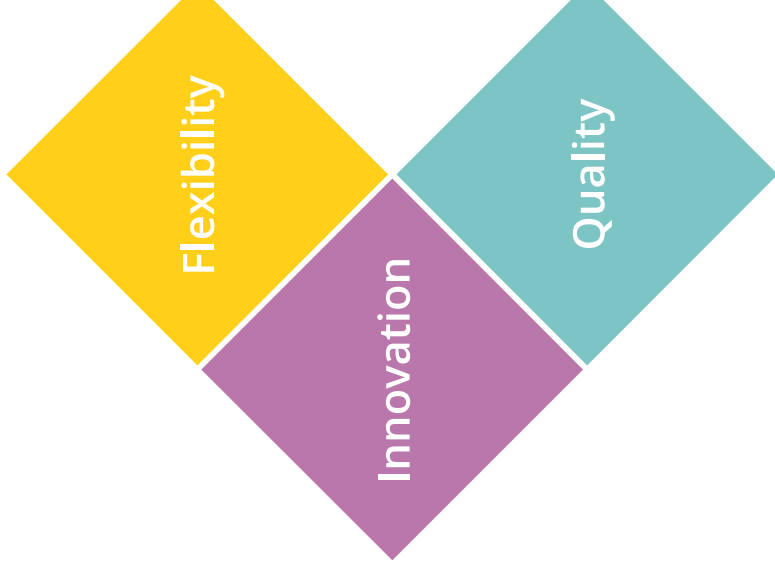



SICO® Sales and Support

Field Sales Regional Sales Managers

SICO's Education Sales Managers are based all over the UK and each one has a designated territory to look after. If you have not met yours yet, then please call sales support so this can be arranged.

Sales Support

Sales support is carried at our offices in Kent. The team offer great service to all our customers and are the interface between our customers and other SICO® Europe departments.



UK MATERIAL SOURCING

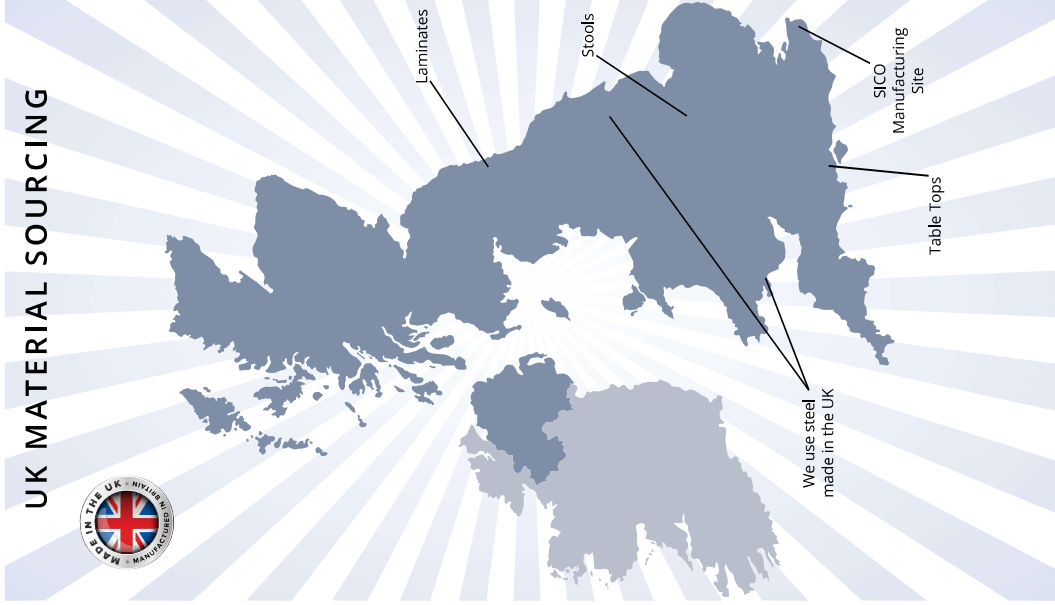

UK Manufacturing

Our manufacturing plant is in Kent and employs around forty people. Staff retention is high, with a high number of long serving employees. To book factory tour, please contact your Regional Sales Manager or the office so suitable dates can be arranged.



SICO® UK Sustainability

Nationwide Deliveries

Your products will be delivered on our own vehicles and SICO® employed drivers. Our friendly and helpful delivery drivers will take away all packaging, fit stools and will show you how to operate your products safely and correctly.



Recycling

If you are replacing your tables, SICO® will happily recycle your old tables for a nominal charge of £20 per table.

Low Carbon Footprint

Our materials are sourced in the UK and products are manufactured in our own factory in Kent, giving you access to products with an industry leading low carbon footprint.

SICO® Green Movement

At SICO® we are constantly developing products and services that use renewable resources, minimise environmental impact and follow the principles of sustainable design.

As part of this commitment, a growing number of SICO® products have been certified with the GREENGUARD® mark of distinction. All these products have passed stringent independent testing to affirm that they meet the high standards set by the GREENGUARD® Environmental Institute for product emissions into the indoor air stream.

The FSC certification is considered the "gold standard" designation for wood harvested from forests that are responsibly managed, socially beneficial, environmentally conscious, and economically viable. For more information on the SICO® Green Movement and Greenguard certified products visit our website www.sicoinc.com



Optimising your space with innovative mobile educational equipment

For over 60 years, SICO® Europe have supplied innovative mobile folding furniture solutions to educational establishments. SICO® products maximise space and time, they also transform spaces into versatile, multi-purpose environments. **One room, one day, multiple uses.**

Dining Room

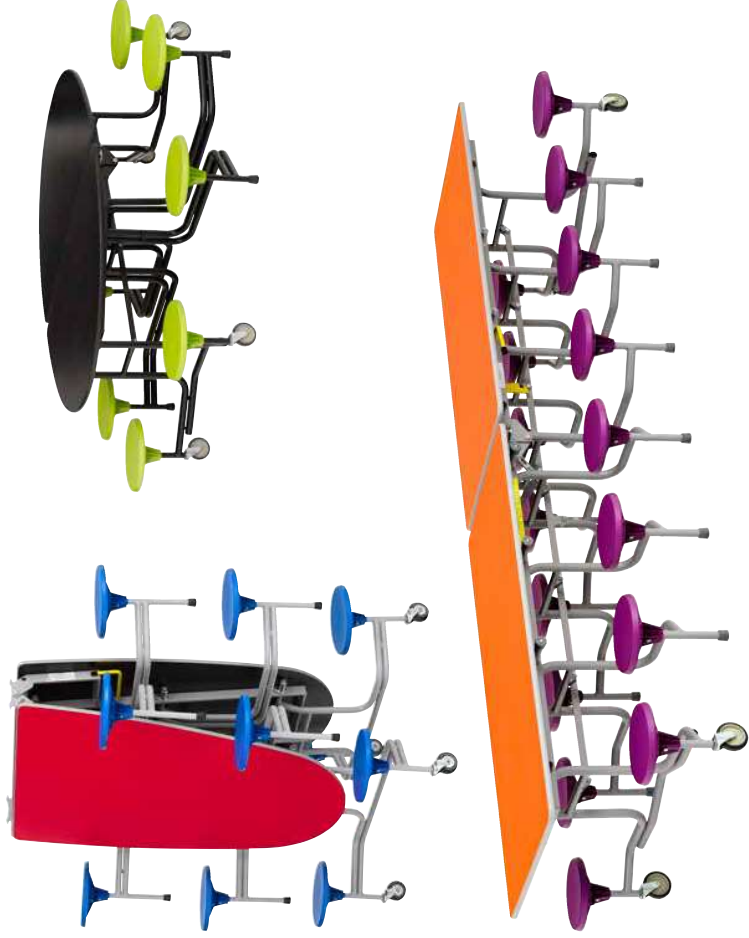

Tables

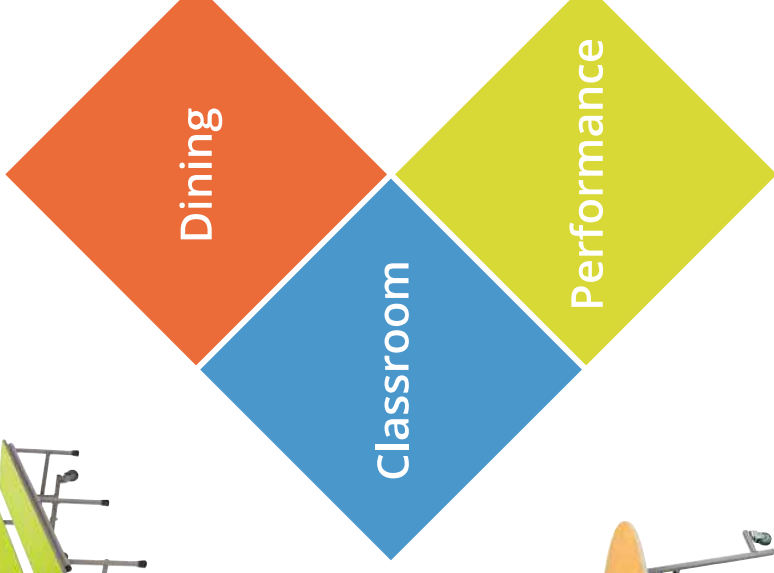

Stages and Performance



E A R L Y Y E A R S

Early Years Foundation Range



Early Years height - 610mm high.

Designed specifically for Early Years.

Suitable for guided play, classroom activities, breakout sessions and dining.

TTK93-24



TTK93-24

SICO® the only choice for Early Years

TTJ103-24



Easy wipe-clean surface.

SICO® Armor-Edge® - is incredibly hard wearing and hermetically seals the table top against moisture and bacteria.

Seating solutions for the younger age group.

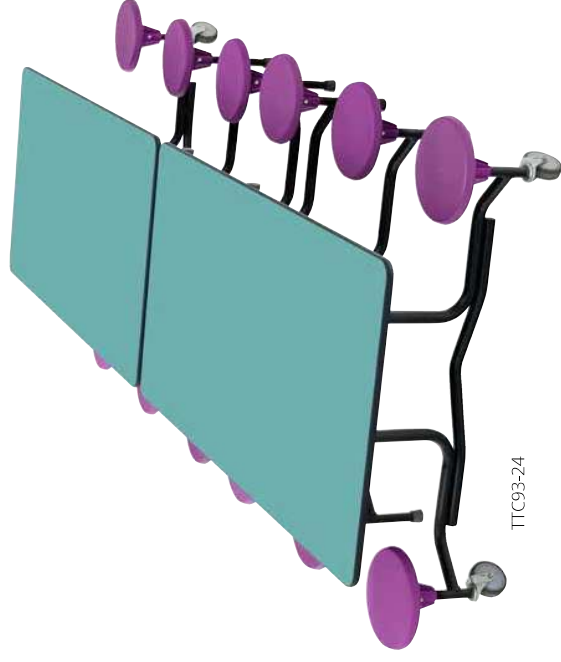

TTC93-24

PRIMARY THROUGH TO SECONDARY SEATING

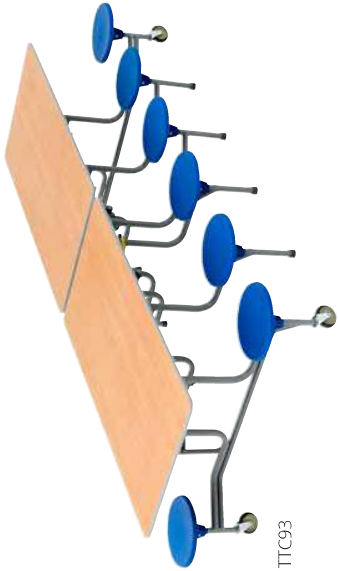

TTC93

Suitable for breakout sessions, classroom activities, and dining.

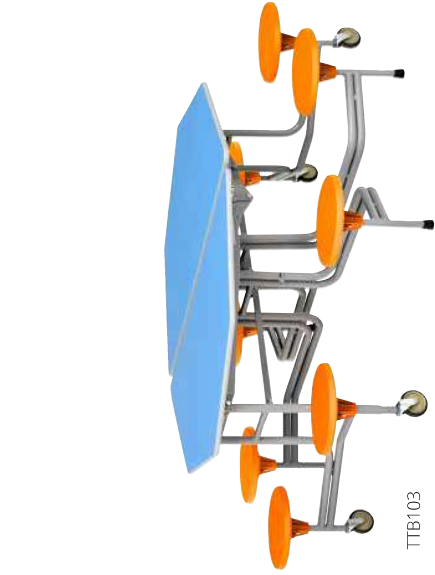

TTB103

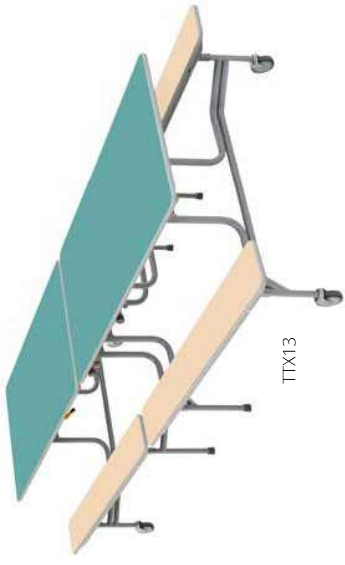

TTX13

Multiple heights available.

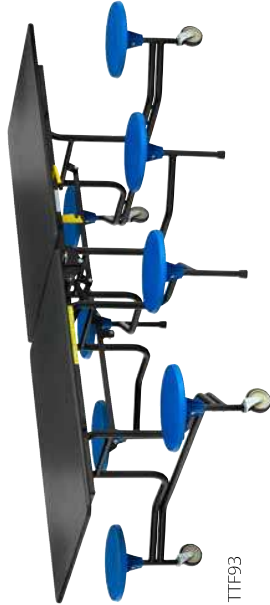

TTF93

SICO® Armor-Edge® - is incredibly hard wearing and hermetically seals the table top against moisture and bacteria.



TTB103B

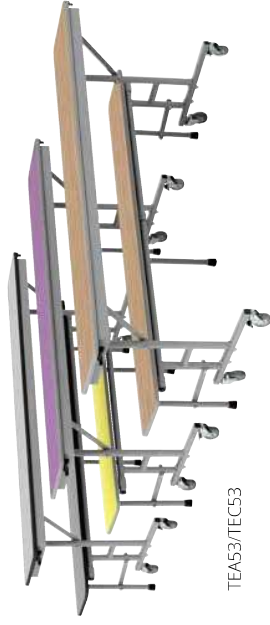

TEA53/TEC53

Variety of seating options.



TTQ53



TBA53 / TBB53 / TBC53

Let us Plan and Design your space

Free Dining Room Planning Service

We want to make sure you get the best possible service, from the handling of your initial enquiry, right through to the completion of your order. As part of our service we offer a Free Space Analysis Survey. We even advise you on the best approach to fire exits, wheelchair access, aisle widths and traffic flow so you can make a fully informed decision before purchasing.

We can help, this is how the planning process works...



We optimise your space

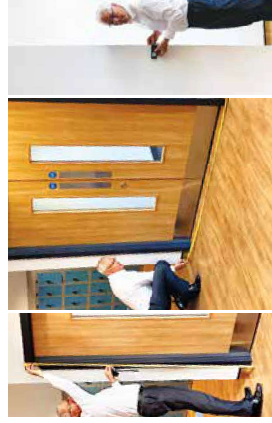
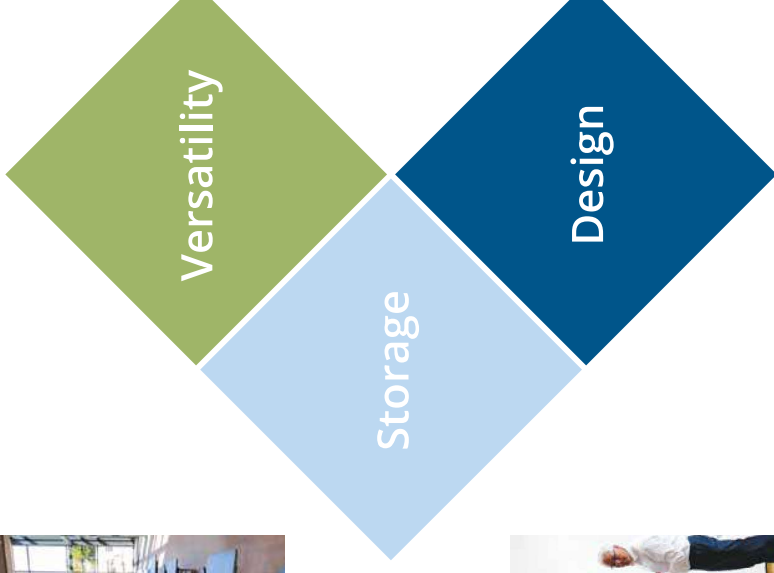
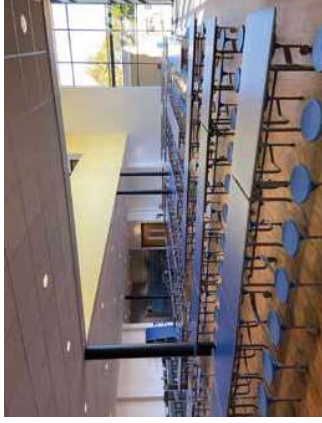

FREE Product Demonstration FREE Space Analysis Survey

We provide valuable and informative **on-site** product demonstrations that enable you to see first hand how quick and easy our tables are to operate.

We provide an **on-site** survey to produce detailed space analysis enabling you to accurately plan your room layout and storage areas.



A member of **LACA** the school food people

Advantages of the SICO® Table Seating Units

If creating a designated dining area is not feasible in your school and lack of space is an issue, SICO®'s easy to use Table Seating Units (TSUs) are the answer. The mobile folding design allows you to convert your hall into a dining area – and back again – within minutes. The tables simply roll into place and fold open where needed, then fold up and roll back into storage until the next time. Our tables are designed to make life easier by saving you precious time, space and ultimately money.

From this...

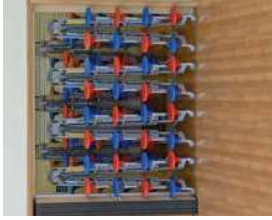

To this...



In less than 20 minutes!

No lifting - simple one person operation



Key benefits of Table Seating Units

- Speed of set up and pack away
- Labour saving - strong financial saving
- Reduction in noise - no chair scraping the floor
- Floors are easily cleaned
- Enables multiple use of space
- Wide range of sizes and shapes to encourage social dining
- Hermetically sealed

Clean up time is cut by more than half
SICO® TSU's clean, fold, roll and reset in a fraction of the time that it takes to move, clean and reset tables and loose chairs.

Serve up to 30% more people
Separate tables and chairs require extra aisle space to allow room for the chairs to slide in and out. SICO® TSU's can be set out closer together without chairs interlocking.

Tables can pay for themselves in as little as two years
The massive saving that you'll make in staff time alone will pay for your SICO® tables within a short space of time.

Unique transit lock override feature
SICO® TSU's allow you to override the transit lock giving you up to 30% additional storage space.

Armor-Edge®
Hermetically sealed edges that reduce contamination, as no voids for debris where bacteria can grow.

Time Saving

Single Person Operation

Increased Capacity



What makes a SICO® Table Seating Unit so special



• SICO® Armor-Edge® - is incredibly hard wearing and hermetically seals the table top against moisture.

Wide choice of laminate options see page 38 - 39 for full range of colour options

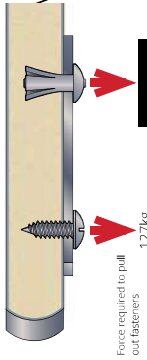

- SICO® Solid MDF Core - Laminate tops are made with extremely durable 18mm MDF core material that is stronger than plywood or chip board. It is lightweight, and resists warping.
- Tamper proof expansion rivets - no screws to work loose.



• Aircraft lock nuts - used at all pivot points. Nuts are tamper resistant and won't loosen over time for increased safety.



• Centre gravity lock bar - will prevent accidental folding of the table. Easily released from either side.



• Floating fold torsion bar - torsion bar lift assist system makes folding and unfolding tables fast, easy and almost effortless.



• 10 colour option of high quality easy clean stools



• Non-marking 10cm wheels - allow smooth, easy table handling
• Non-marking glides - on the legs to protect your floors

Dining Seating Solutions

12 Seat Rectangular Table Seating Unit - TTC93



- Easy wipe-clean surface.
- One-piece stools - hard wearing. Available in 10 different colours and two sizes - 25cm or 33cm.
- SICO® Armor-Edge® - incredibly hard wearing and hermetically seals the table top against moisture and bacteria.
- Full operating instructions - for easy user training, complies with Manual Handling Regulations.
- Stools fixed to tables - no extra aisle space required for movement of chairs. Aisles remain clear.
- Tested and certified to EN1729 and BS4875

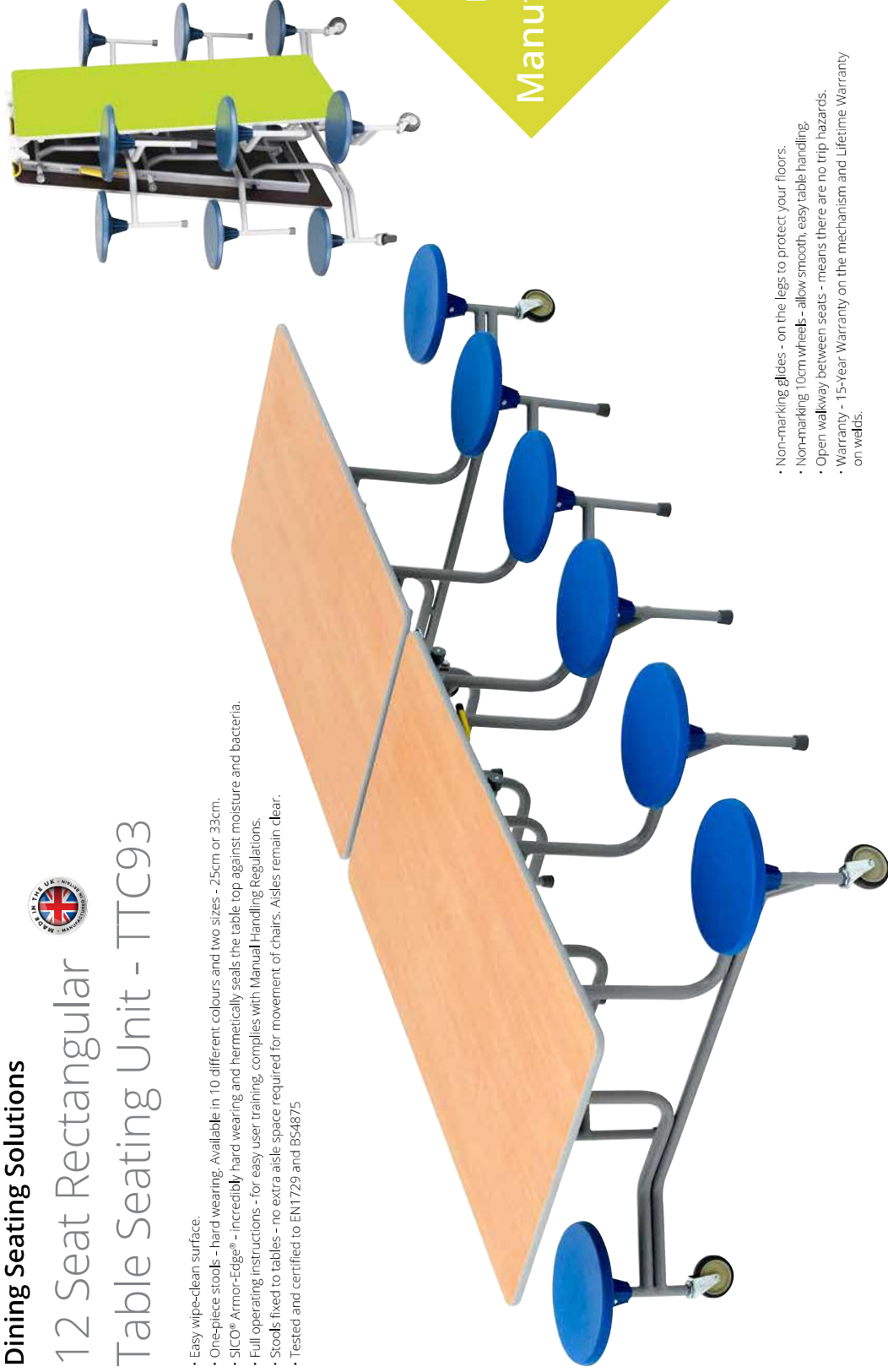

Best Seller

UK Manufactured

Must Have Product

- Non-marking glides - on the legs to protect your floors.
- Non-marking 10cm wheels - allow smooth, easy table handling.
- Open walkway between seats - means there are no trip hazards.
- Warranty - 1.5-Year Warranty on the mechanism and Lifetime Warranty on welds.

Model	Table Length 'A' cm	O/A Width 'B' cm	Table Height 'C' cm	Stool Height 'D' cm	Stool Diameter 'E' cm	Transit Lock Height 'F' cm	Transit Lock Height 'G' cm
TTC93-24	307	132	62	35	25.4	172.5	85
TTC93-26	307	150	67	35.5	32.4	177.5	103
TTC93-28	307	150	74	44	35.4	185	113

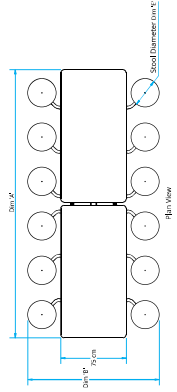

Range of heights to suit all ages

Table height:	74cm	11 years to adult
	69cm	7 to 11 years
	67cm	4 to 11 years
	62cm	4 to 7 years

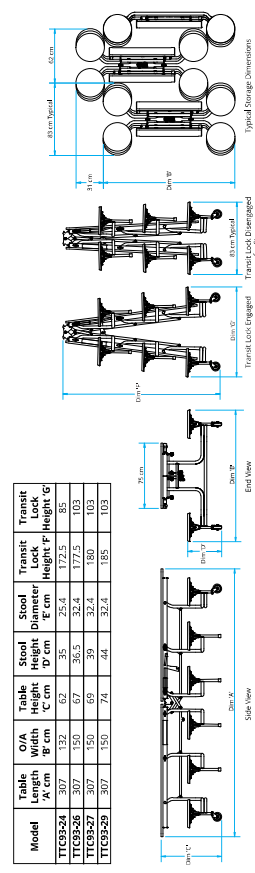

8 Seat Rectangular Table Seating Unit - TTF93



- Easy wipe-clean surface.
- One-piece stools - hard wearing. Available in 10 different colours and two sizes - 25cm or 33cm.
- SICO® Armour-Edge® - incredibly hard wearing and hermetically seals the table top against moisture and bacteria.
- Full operating instructions - for easy user training, complies with Manual Handling Regulations.
- Stools fixed to tables - no extra aisle space required for movement of chairs. Aisles remain clear.
- Tested and certified to EN1729 and BS4875.



- Non-marking glides - on the legs to protect your floors.
- Non-marking 10cm wheels - allow smooth, easy table handling.
- Open walkway between seats - means there are no trip hazards.
- Warranty - 15-Year Warranty on the mechanism and Lifetime Warranty on welds.

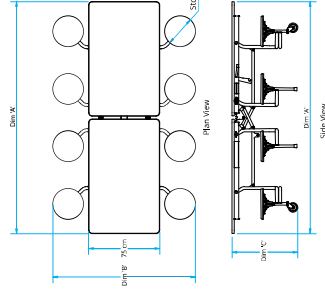

Model	Table Length A cm	Table Width B cm	O/A Width C cm	Table Height D cm	Stool Height E cm	Stool Diameter F cm	Transit Lock Height G cm	Transit Lock Height H cm
TTF93-25	245	150	150	69	25	32.4	74.5	38
TTF93-27	245	150	150	69	27	32.4	74.5	38
TTF93-29	245	150	150	74	29	32.4	79.5	38

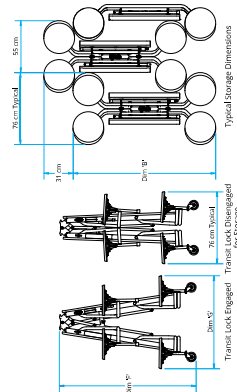

Range of heights to suit all ages

Table height guide:

- 74cm 11 years to adult
- 69cm 7 to 11 years
- 67cm 4 to 11 years



The TTX13 Series Bench Table Seating Unit has been designed to offer increased seating solutions with a market competitive price point.

Giving you all the flexibility you need, the TTX13 Series Bench Unit can sit up to 16 primary age children or 12 adults.

NEW

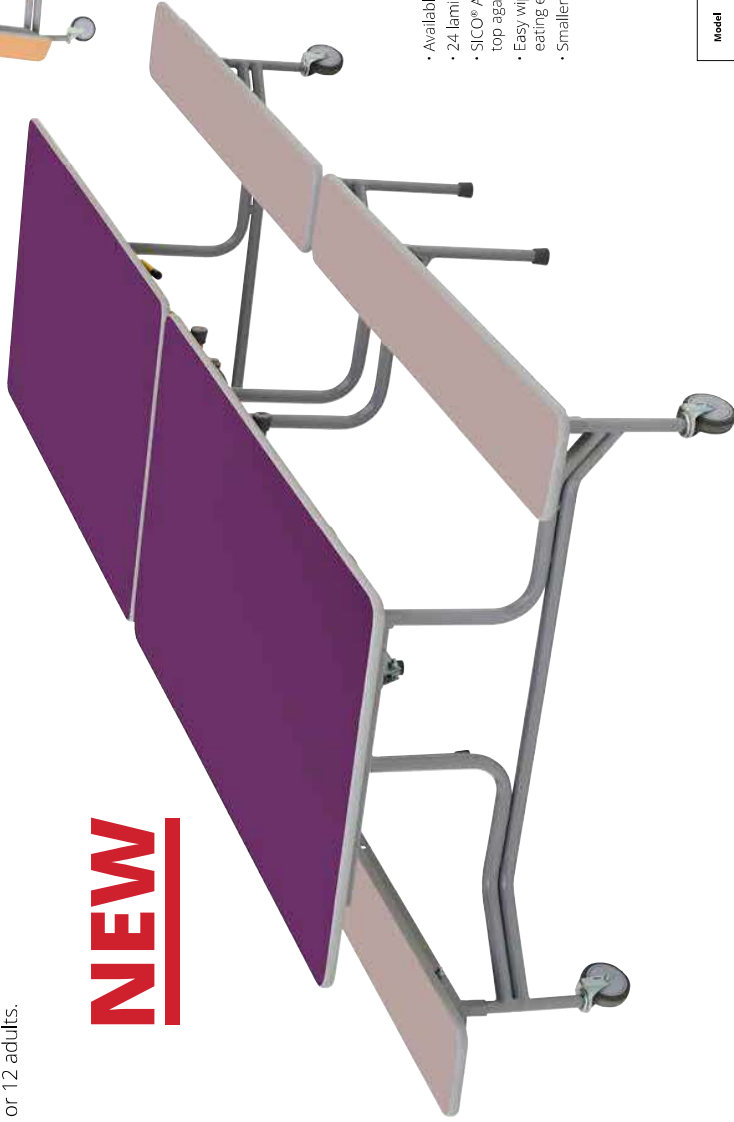

Range of heights to suit all ages

Table height guide:
 75cm 11 years to adult
 70cm 7 to 11 years
 67cm 4 to 11 years

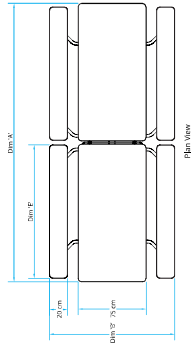

New Product

Market Competitive

Bench Seating

- Available in 660mm, 690mm or 740mm heights.
- 24 laminate colours to choose from on tops and benches.
- SICO® Armor-Edge® - incredibly hard wearing and hermetically seals the table top against moisture and bacteria.
- Easy wipe clean surface, able to withstand robust cleaning to ensure a safer eating environment.
- Smaller storage footprint compared to other TSU's and competitor products.

Model	Table Length 'A' cm	O/A Width 'B' cm	Table Height 'C' cm	Bench Height 'D' cm	Bench Height 'E' cm	Transit Lock Height 'F' cm	Transit Lock Height 'G' cm
TTX13A26	307	75	67	38	147	178	83
TTX13A27	307	75	70	40	147	180	83
TTX13A29	307	75	75	45	147	185	83

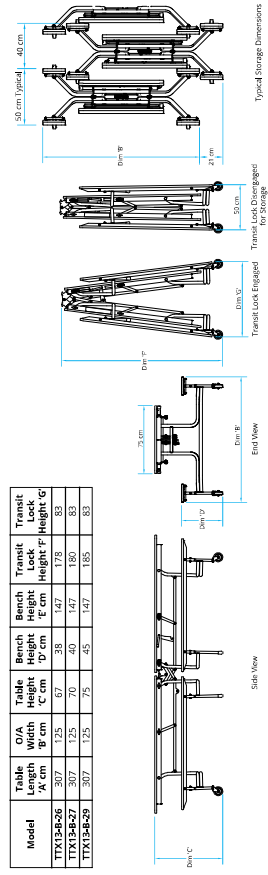

8ft BY-65 Mobile Folding Bench Table - TBA53

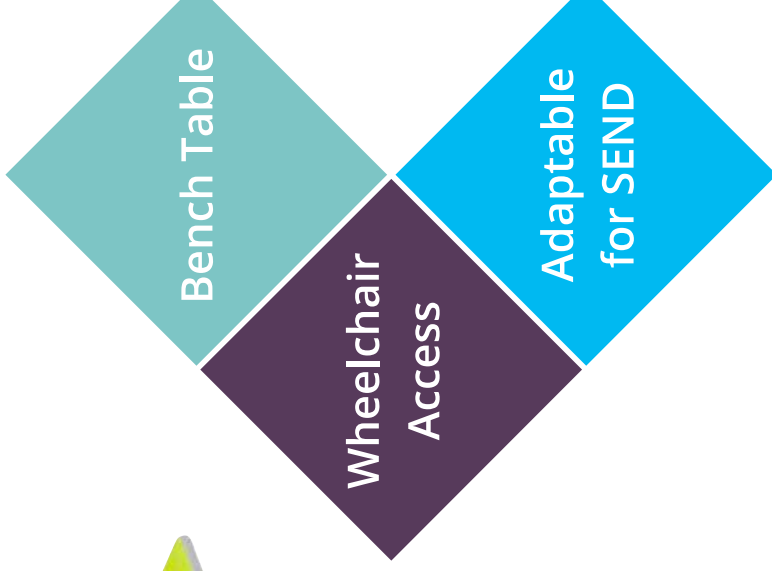
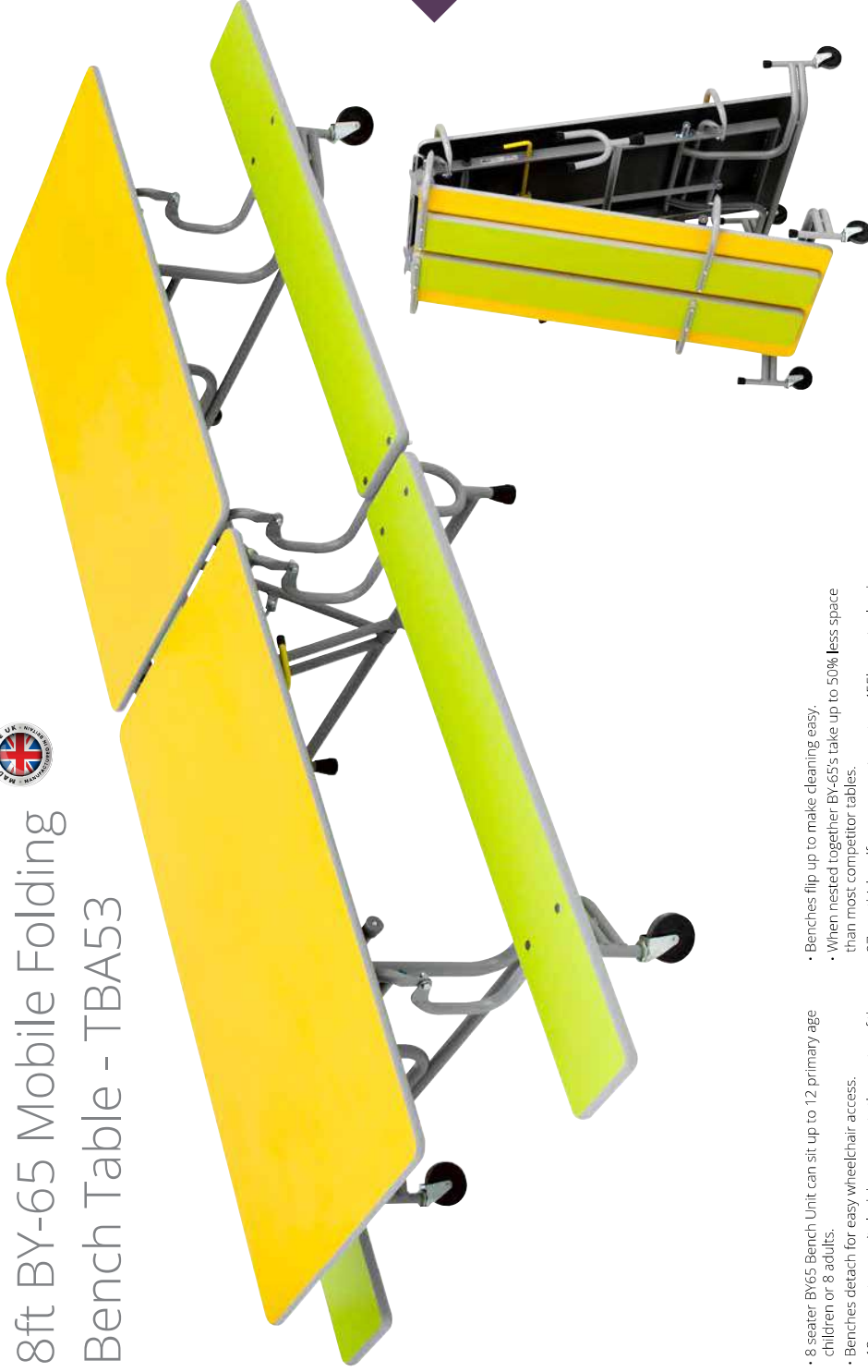

- 8 seater BY65 Bench Unit can sit up to 12 primary age children or 8 adults.
- Benches detach for easy wheelchair access.
- 13mm centre gravity lock bar prevents the centre of the unit being raised if someone sits on an end; the bar is easily released from either side.
- Benches flip up to make cleaning easy.
- When nested together BY-65's take up to 50% less space than most competitor tables.
- 27mm thick mdf core supports up to a 455kg centre load on the benches.
- Adaptable for "SEND" (Special Educational needs & disability).

Range of heights to suit all ages

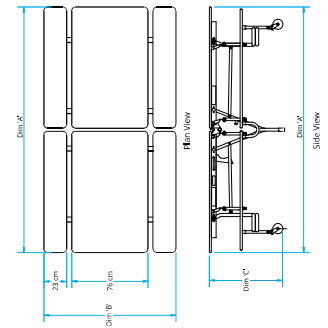
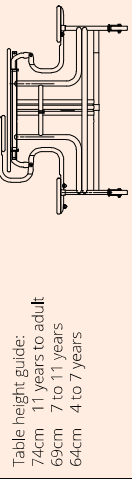

Model	Table Length (mm)	O/A Width (mm)	Table Height (mm)	Bench Weight (kg)	Bench Height (mm)	Transit Height (mm)	Transit Weight (kg)
TBA53-25	2443	1250	64	33.5	122	153	50
TBA53-27	2444	1250	69	38.5	122	153	50
TBA53-29	2444	1250	74	43.5	122	153	50

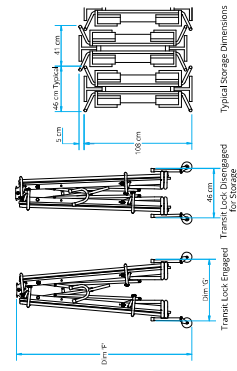



10ft BY-65 Mobile Folding Bench Table - TBB53

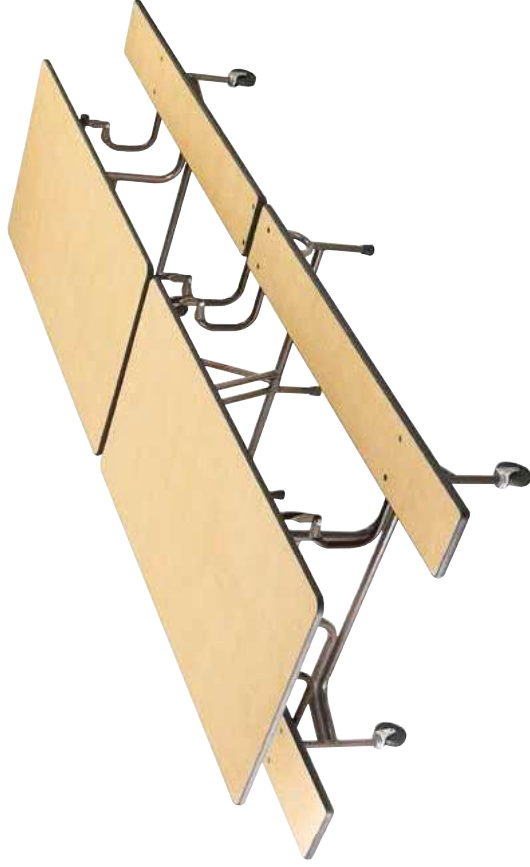

- 12 seater BY65 Bench Unit can sit up to 16 primary age children or 12 adults.
- Benches detach for easy wheelchair access.
- 13mm centre gravity lock bar prevents the centre of the unit being raised if someone sits on an end; the bar is easily released from either side.
- Benches flip up to make cleaning easy.
- When nested together BY-65's take up to 50% less space than most competitor tables.
- 27mm thick mdf core supports up to a 455kg centre load on the benches.
- Adaptable for "SENDY" (Special Educational needs & disability).

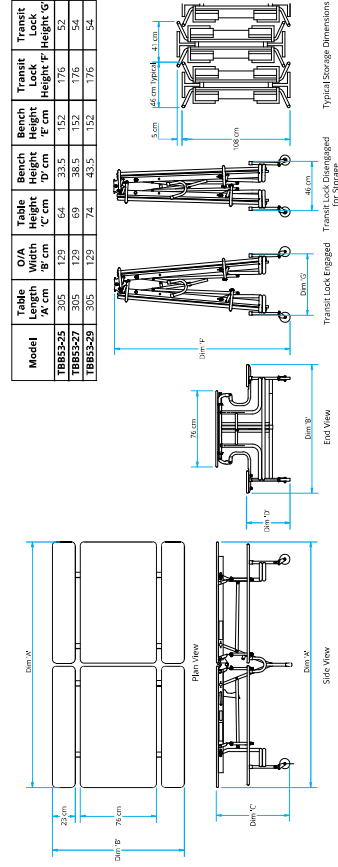

Model	Table Length A cm	O/A Width B cm	Table Height C cm	Bench Height D cm	Bench Height E cm	Transit Lock Height F cm	Transit Lock Height G cm
TBB52-25	305	129	64	35.5	152	176	52
TBB52-27	305	129	64	35.5	152	176	52
TBB52-28	305	129	64	43.5	152	176	54



12ft BY-65 Mobile Folding Bench Table - TBC53



- 16 seater BY65 Bench Unit can sit up to 20 primary age children or 16 adults.
- Benches detach for easy wheelchair access.
- 13mm centre gravity lock bar prevents the centre of the unit being raised if someone sits on an end; the bar is easily released from either side.
- Benches flip up to make cleaning easy.
- When nested together BY-65's take up to 50% less space than most competitor tables.
- 27mm thick mdf core supports up to a 455kg centre load on the benches.
- Adaptable for "SENDY" (Special Educational needs & disability).

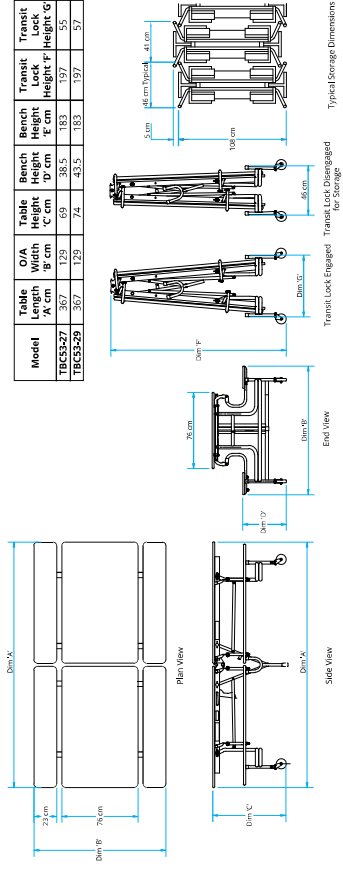
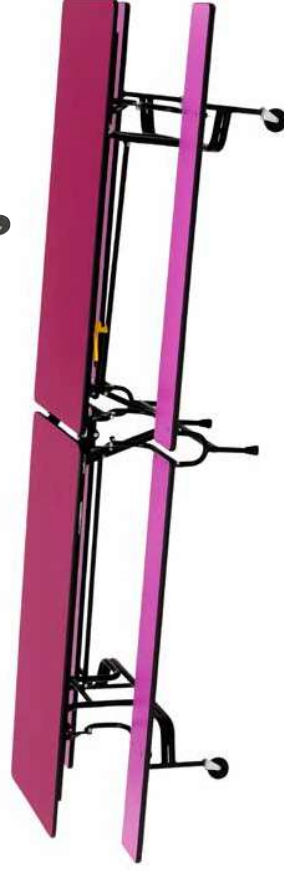

Model	Table Length A cm	O/A Width B cm	Table Height C cm	Bench Height D cm	Bench Height E cm	Transit Lock Height F cm	Transit Lock Height G cm
TBC53-27	367	129	74	49	35.5	183	57
TBC53-28	367	129	74	49	43.5	183	57

Communicator Table Seating Unit - TTQ53



- Break out group work tables.
- Easy operation.
- Easy to locate to storage space.
- Communication made easy.
- Unique elliptical table top to encourage greater pupil interaction during dining.
- 12 seater units.
- Length: 3050mm.
- Height: 660mm, 690mm & 740mm.
- Adaptable for "SEND" (Special Educational needs & disability).

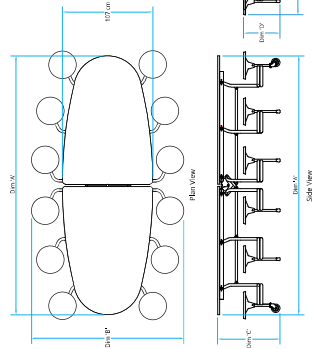
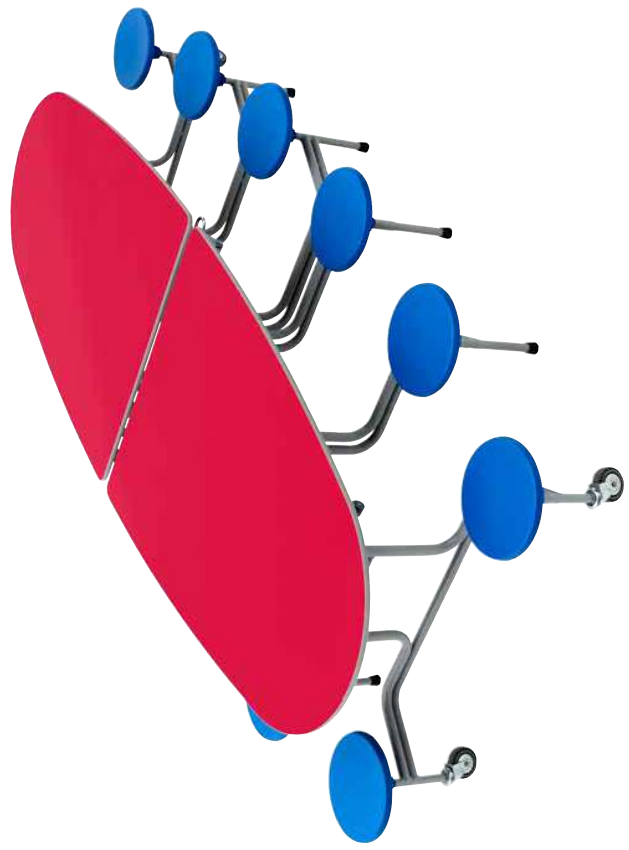
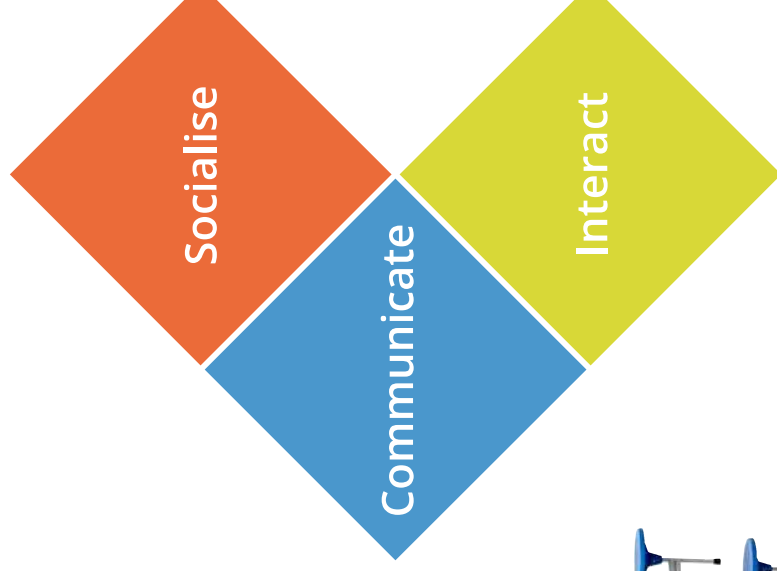
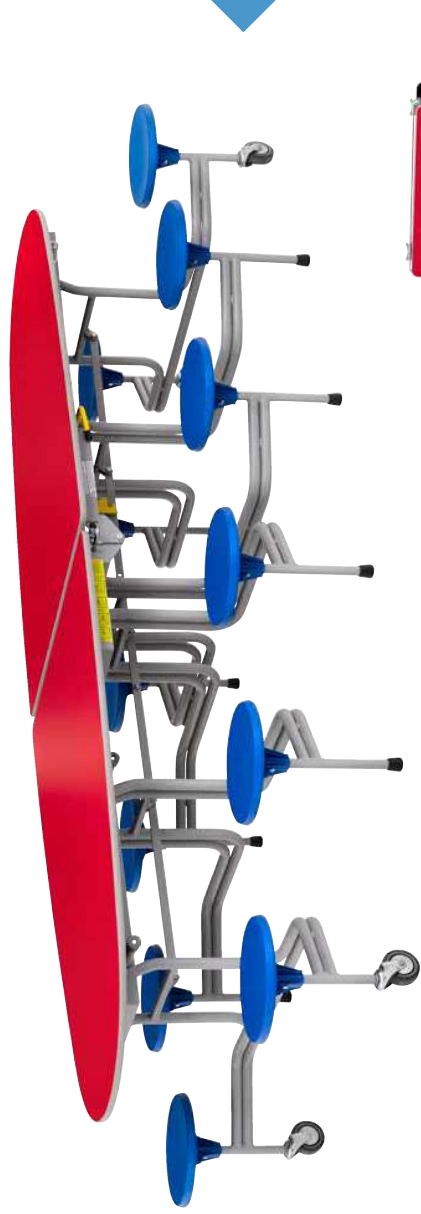

Model	Table Length 'A' cm	O/A Width 'B' cm	Table Height 'C' cm	Stool Height 'D' cm	Stool Diameter 'E' cm	Transit Lock Height 'F' cm	Transit Lock Height 'G' cm
TTQ5248	306	780	67	35	32.4	187	111
TTQ5247	306	780	69	35.3	32.4	189	111
TTQ5249	306	780	74	43.3	32.4	194	111

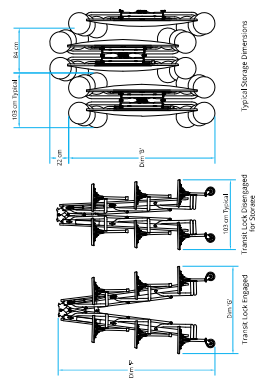



Graduate Table Seating Unit with Stools - TTG63

- These tables seat around 30% more students than standard tables and chairs.
- Stool table is available in oval and octagonal seating 8 people
- Comfortable seating for both adults and children.
- Heights: 610mm, 660mm, 690mm & 740mm.
- Adaptable for "SEND" (Special Educational needs & disability).

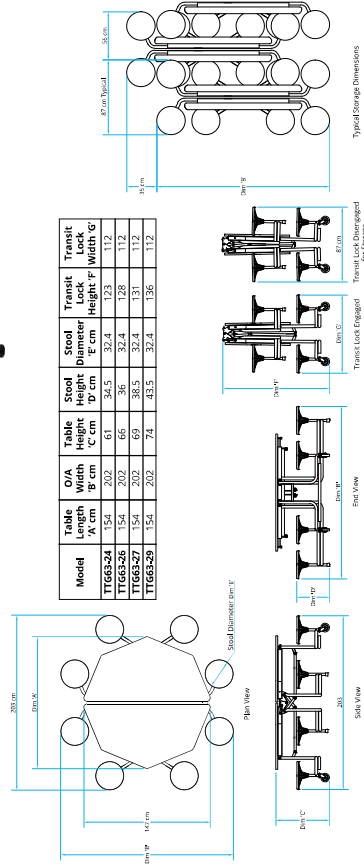
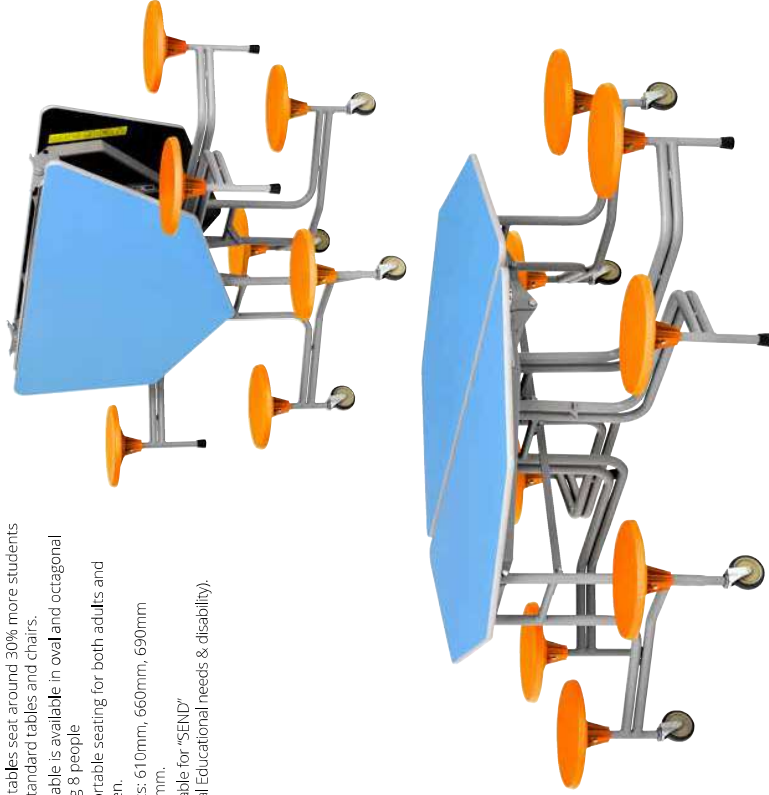

Graduate Table Bench Units with Benches TTB103B or Stools TTB103

- These tables seat around 30% more students than standard tables and chairs.
- Bench version is available in **oval only** and can seat 8-12 people
- Comfortable seating for both adults and children.
- Heights: 610mm, 660mm, 690mm & 740mm.
- Adaptable for "SEND" (Special Educational needs & disability).

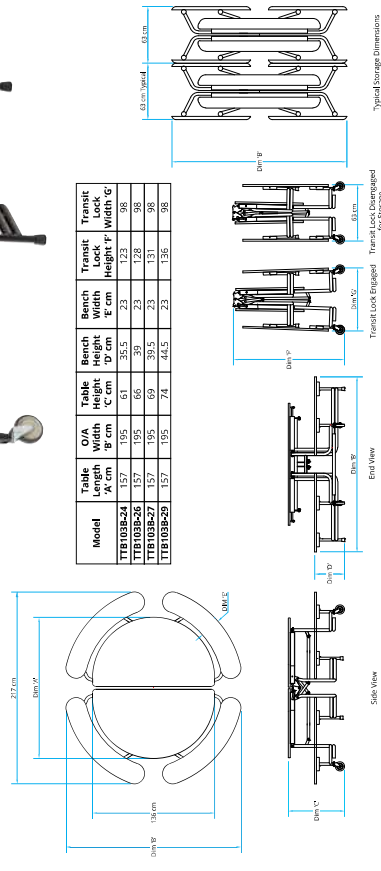

Versatile Seating Systems

2800 Bench - 3 in 1 Unit TEA53 / TEC53



Dining style

- SICO® 2800 Bench 3 in 1 units can nest together for compact storage, each additional unit requires only an extra 200mm of storage space.
- Suitable for wheelchair access.
- Wheel locks secure the units into place and won't damage floor or carpet.



Multi-purpose style suitable for wheelchair users



Additional units require an extra 200mm of storage space

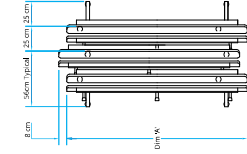
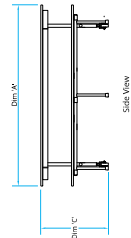
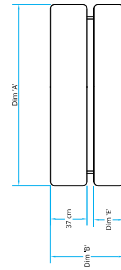

Typical Storage Dimensions

Model	Table Length 'A' cm	Table Width 'B' cm	Table Height 'C' cm	Bench Height 'D' cm	Bench Width 'E' cm	Tray Height 'F' cm	Tray Lock Height 'F' cm
TECS3-27	244	74	69	37.5	30	80	85
TECS3-29	244	74	74	43.5	30	85	85

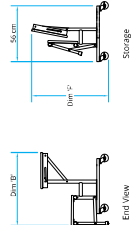

Storage

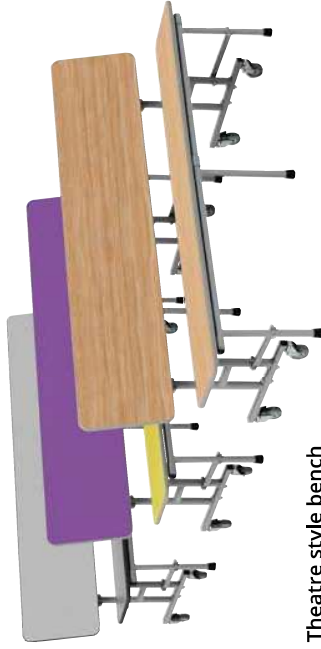

Theatre style bench seating with backrests

- Automatic locking system ensures table tops stay locked in place when folded.
- 14-gauge square tubing and top frame ensures superior strength and durability.
- Two heights available – 27" (690mm) and 29" (740mm).
- Two lengths available – 6ft (1825mm) seats 3/5, 8ft (2435mm) seats 4/6.

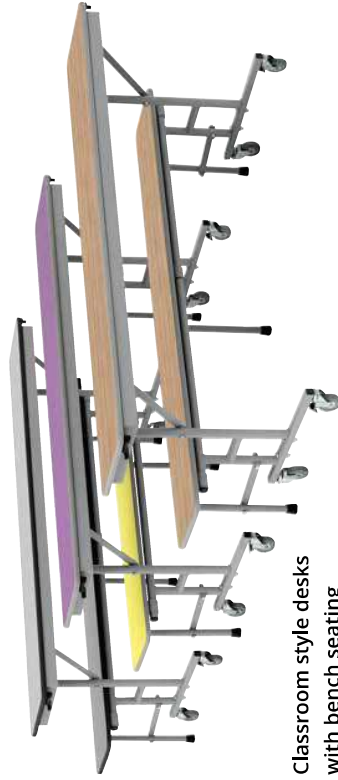

Classroom style desks with bench seating

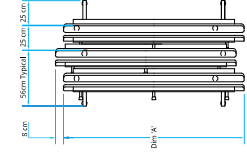
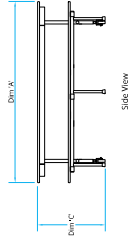
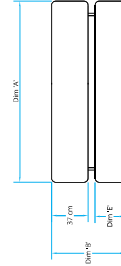

Typical Storage Dimensions

Model	Table Length 'A' cm	Table Width 'B' cm	Table Height 'C' cm	Bench Height 'D' cm	Bench Width 'E' cm	Storage Height 'F' cm
TEAS3-27	183	74	69	37.5	30	80
TEAS3-29	183	74	74	43.5	30	85

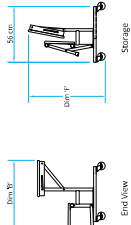

Storage

Tables

Flip-Tech Meeting & Workspace Tables



Flip it, Roll it, Nest it, Store it

Designed in the UK, Flip-Tech Meeting & Workspace Tables incorporate an innovative neutrally pivoted release mechanism, with integrated adjustable dampening. Available in a variety of styles and able to accommodate an extensive range of top shapes and sizes. Flip-Tech Table frames provide a robust, reliable & affordable solution for reconfigurable furniture within all environments.



Cable Management System



- Multiple Top Options
- Durable Edge
- Linking Capability
- Three Standard Top Shapes
- Multiple Finish Options
- Tubular Steel Leg and Frame
- Power & USB Port & Cord Storage
- Two Standard Leg Styles
- Swivel Casters
- Modesty Panel



Flexible power and data configurations to meet your requirements. International socket variations available on request.



Configurable to the Limits of Your Imagination

Link these tables to one another to create the perfect layout for your event. Combine different shapes for unconventional setups. Linking tables is as easy as rolling them together and latching.



Tables

Socializer Whiteboard Table

- An easy to use table that requires no lifting or caddy but rolls on its own wheels.
- Each table has 12 height adjustments, from 740mm to 1040mm.
- Round or rectangular table tops available, round has a diameter of 910mm.
- Armor-Edge®.
- Tables nest together due to a unique folding table top design and inter-locking legs.
- Hermetically sealed to reduce bacterial contamination.
- Dry wipe laminate top for use as a white board.
- Excellent for break out sessions.
- Magnetic version available.



Socializer Table

- An easy to use table that requires no lifting or caddy but rolls on its own wheels.
- Each table has 12 height adjustments, from 740mm to 1040mm.
- Round or rectangular table tops available, round has a diameter of 910mm.
- Armor-Edge®.
- Tables nest together due to a unique folding table top design and inter-locking legs.
- Hermetically sealed to reduce bacterial contamination.
- Dry wipe laminate top for use as a white board.
- Excellent for break out sessions.
- Magnetic version available. Full range of laminate top colours.



Tables

Pacer Mobile Folding Table

These tables fold and roll quickly and easily into storage and back into action the minute you need them.

- Hexagon - Seats 6.
- Round - 3 sizes, Seats 4-12.
- Square - Seats 6.
- Octagon - Seats 8.
- Rectangle - 6 sizes, Seats 4-8.
- Serpentine - Seats 4.
- Oval - 2 sizes, Seats 6-10.
- Full range of laminate top colours.



LB Mobile Folding Table

LB tables are a great choice when you prefer to use separate chairs and need a mobile folding table.

- One person can operate any size table through the torsion bar lift assist.
- 5 rectangular size tables available.
 - 753mm x 1503mm,
 - 753mm x 1807mm,
 - 753mm x 2439mm,
 - 753mm x 3039mm,
 - 753mm x 3561mm.
- Full range of laminate top colours.
- other sizes are available.



MultiApp Table



Choose from a variety of table top shapes and sizes to create the perfect fit for any purpose, including catering, school, classrooms, meeting rooms, conference rooms or registration desks.

- This versatile table has a modesty panel, lockable casters, table to table linking and pneumatic folding assist function.
- A great computer station on wheels with wire management.
- Tops fold and tables nest together.
- No leg obstructions under table.
- No caddy required - one person can easily roll this table.
- Full range of laminate top colours.

Mobile Folding Conference/Elip Table



These stylish tables offer a perfect mobile folding solution for any conference room, boardroom or general office area.

- Choose from any SICO® U.S. laminate colours.
- Needs no caddy, one person can easily roll table into service or storage, no lifting necessary or parts to assemble.
- Frame designed for form and function, attractive curves are complimented with a powder coated finish designed to stand up to heavy duty use.
- Requires a minimum of storage space.



Pacer II Table - An Innovative One-Piece Top Table

The One-Piece Top Mobile Folding Pacer II Table uses a one-piece seamless laminate table top, providing guests a spacious surface for their food & beverages.

- Elegant oval tube frame.
- Available in either nickel chrome or black powder coat finish.
- Frame design provides obstruction free seating for all guests.
- Table can easily be operated by one person.
- Each table stores on its own four caster wheels, so in just seconds a table can fold and be ready to roll to its next event, or into storage.
- Available in Oval, Round or Octagonal.



Portable Performance Stages

Series 2000 Mobile Folding Stage



- The quickest stage to set out and pack away.
- A self-storing unit requiring single person set up, a great labour saver.
- Single or dual height mode with 150mm or 200mm increments.
- Deck sizes: 91cm x 244cm - single height, 122cm x 244cm - single/dual height, 183cm x 244cm - single/dual height.
- Point loading 500kg per square metre.
- Heavy duty non-marring wheels protect floors.
- Vinyl coated steel edge provides long lasting wear and durability.
- Hook and Loop edging enables easy drape attachment.
- Unit rests on 8 direct-to-floor load bearing legs that stabilise the stage.
- Deck surface options:
 - Hard wearing carpet.
 - Durable scratch resistant tuff-deck.

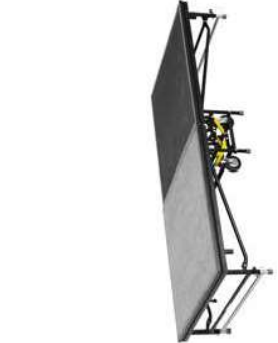
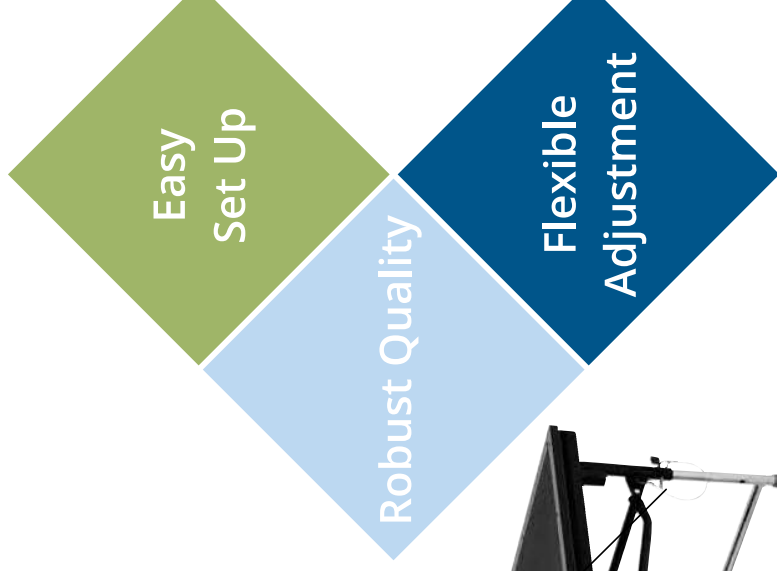
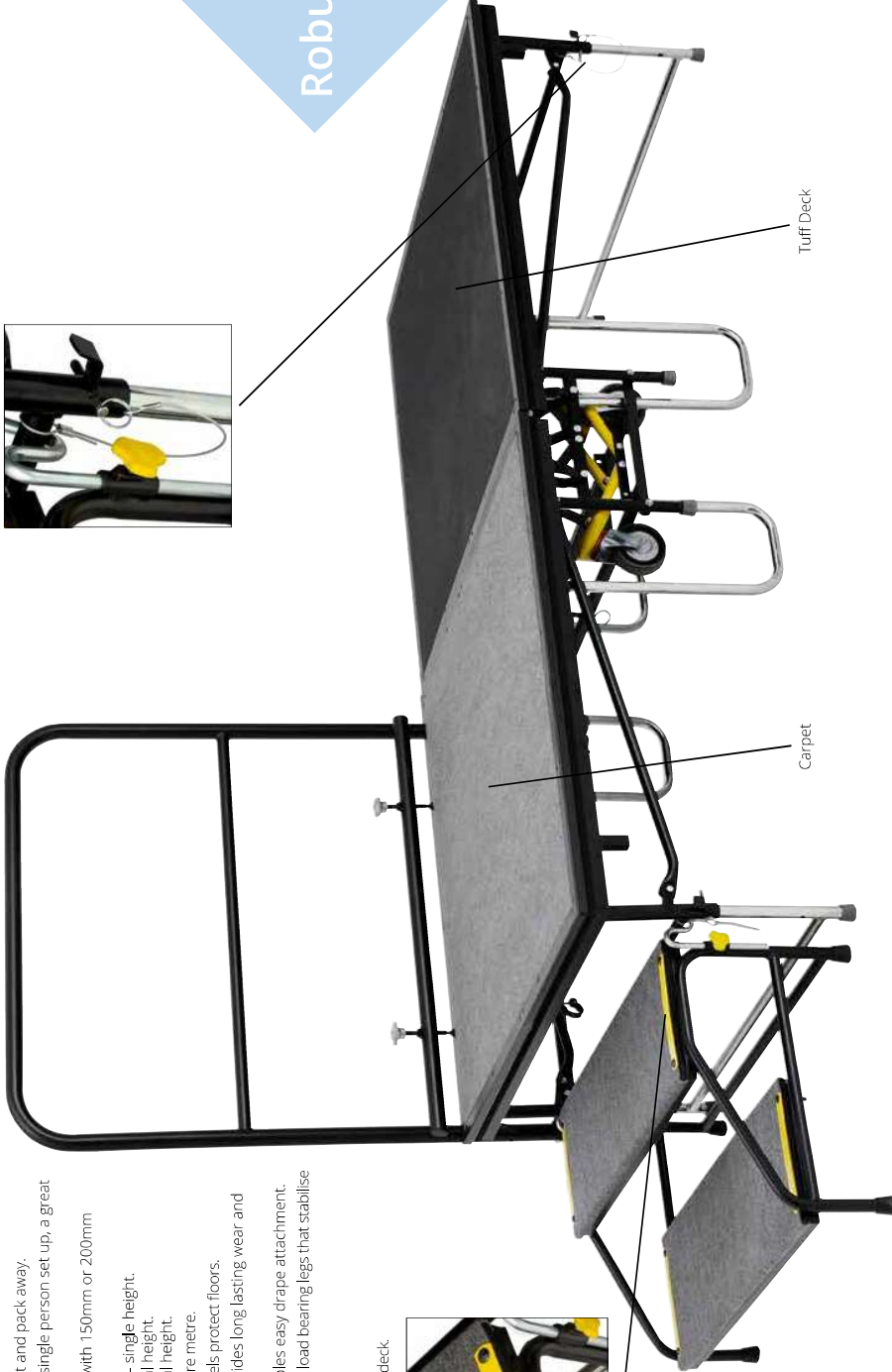

Portable Performance Stages

Stage Accessories

Complete your SICO® staging system with this wide range of stage accessories:

- Stage curtains, backdrop frames and stage skirting. Available in many colours to match your decor.
- Universal ramps - mobile folding units; allowing fast set-up. Ramp surface options: carpet or Tuff-Deck.
- Universal guard rails & guard rail covers - guard rails are a must for any stage set-up.



Chair Stops



Accessibility Ramps



Skirting



Carpet

Tuff-Deck

Guard Rails



Steps, single or double options available



Stage curtains and backdrop frames



Portable Performance Stages

Tri-Height Mobile Folding Stage

- A versatile stage, easy to adjust in 152mm increments.
- A full range of sizes and heights available.
- Minimal effort needed to set up, keeping staffing and labour costs to a minimum.
- Easy to fold and change heights with automatic snaplocks.
- Decks can be reversed without dismantling the stage.
- A rigid one-piece frame supports the decks to spread load evenly.
- Exclusive built-in stage connectors provide a firm, positive lock.
- Easily transported due to its low centre of gravity when folded.

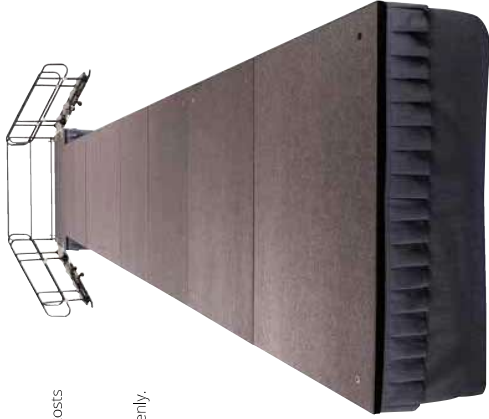

Harmony Choral Risers

- 3 step and 4 step design.
- Multi shape configuration.
- High quality construction fully carpeted, quiet decks.
- SICO® exclusive deck lock allows changes to deck position instantaneously.
- Top row security rail, no gaps between units and 25mm deck overhang for added safety.
- Four wheel design eliminates the need to lift.
- Convenient storage due to 3 and 4-rise folds.
- Shipped fully assembled.



Portable Performance Stages

Insta-Theatre



- A versatile and complete professional theatre system.
- Set up by just two people, ready to use within minutes.
- Highly versatile - multiple configurations are possible.
- Designed exclusively to suit your individual requirements.
- Stores against a wall or in a recess as little as 1.4m deep!



Table Laminate and Stool Colour Options

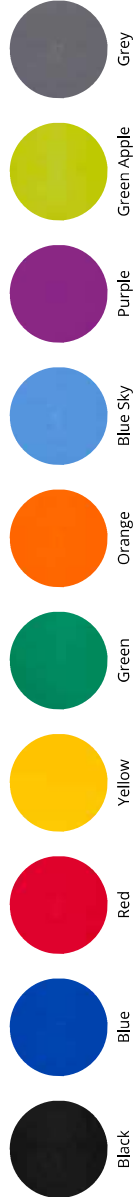

Table laminate options - for Table Seating Units, Classroom Tables and Benches

All table tops use SICO's revolutionary Armor-Edge® for lasting appearance, protection and durability.



Stool Colour options



This colour chart is to be used as a guide only. SICO® cannot accept responsibility for variations in colour against the original material. Please refer to actual laminate and stool samples before ordering.

Let us look after it for you



SICO® products are engineered to offer many years of service. Just like your car, your boiler and other equipment that you rely on, the best way to ensure they keep working for you is to make sure they are properly looked after.

SICO® Service and Maintenance – Benefits

- Wear and tear parts replacements covered in the cost SICO® 'glides' (which protect your floor surface), castors (for easy manual handling) and the seats can succumb to wear and tear. We cover the replacement of these in our packages, which as individual 'repairs' would be inefficient to manage.
- Deal with the manufacturer direct – we know our products and exactly how to look after them, which means they last longer and operate at their optimum.
- Compliance with the PUWER (The Provision and Use of Work Equipment Regulations) 1998 – work meets the relevant regulatory requirements and your staff can be confident that you're safeguarding their welfare.
- Dedicated schedulers and engineers from the same SICO® Europe team that supplied the top quality product in the first place – you have nothing to worry about.
- Free user training provided by engineer during maintenance visits.

How it works

1. Contact SICO® (details below) or speak with your local SICO® Regional Sales Manager.
2. We'll provide a proposal that suits your needs and requirements.
3. Once you've agreed a proposal, we will agree a date for our engineers to attend your site and undertake the work – usually within 4 weeks.
4. On completion of work, our Service Team will devise a report and asset register, which are provided to you for free, as part of the service.
5. We only invoice you after the work has been carried out and for the number of units maintained.
6. Any additional work that we identify as needing to be undertaken is proposed and only ever undertaken with your agreement.

Are your Table Seating Units in need of some TLC?

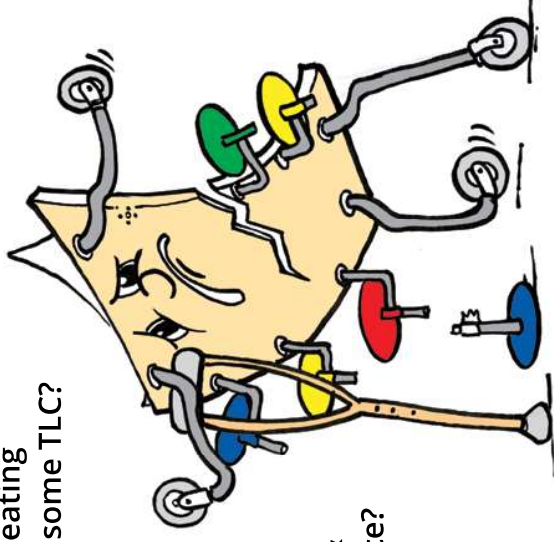

Do you meet **PUWER** Health & Safety compliance?

SICO® now offer health checks on ALL your Table Seating Units

Provision Use Work Equipment Regulations 1998

Health checks will be carried out by your fully trained, professional SICO® Engineer. Please contact Service Sales to add to your current agreement or to discuss further.

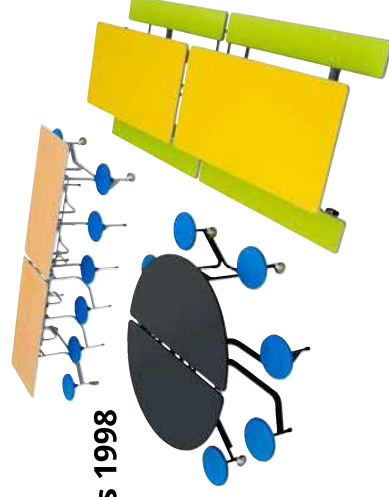

One Health Check for ALL brands of table

CONTACT US NOW for more information: 01303 234000 or serviceandmaintenance@sico-europe.com



Innovative Mobile Furniture
for the Education Market.

SICO Incorporated -
Global Headquarters
SICO America Inc.
Tel: 1 800 328 6138
Fax: 1 952 941 6688
Email: sales@sicoinc.com
7525 Cahill Road
Minneapolis, MN 55439
United States

SICO Asia PTE LTD
Tel: (65) 6500 0800
Fax: (65) 6500 0811
Email: sales@sicoasia.com
1 Clementi Loop #06-06
Clementi West Logis Park
Singapore 129808

SICO Europe Limited
Tel: +44(0) 1303 234 000
Fax: +44(0) 1303 234 001
Email: sales@sico-europe.com
The Link Park
Lympne Industrial Estate
Lympne, Kent CT21 4LR
United Kingdom

SICO Japan Inc.
Tel: +81(3) 3288 0145
Fax: +81(3) 3288-0146
Email: info@sico-japan.com
Daiwashoji Bldg. 1F
3-10-3, Kanda-Misakicho
Chiyoda-ku, Tokyo 101-0062
Japan

SICO Middle East DMCC
Tel: (971) 4 422 8259
Fax: (971) 4 422 8059
Email: sales@sico-me.com
Office 303
Dubai Arch Tower, Cluster G
Jumeriah Lake Towers
P.O. Box 440094
Dubai, UAE

SICO South Pacific Limited
Tel: +61(2) 4336 1333
Fax: +61(2) 4388 4643
Email: sales@sicosp.com.au
3 Blade Close
Berkeley Vale, NSW 2261
Australia

Dining room seating solutions.
Versatile seating systems.
Portable performance stages.
Event and performance staging.

SICO® Europe Limited

www.sicoinc.com